

Fits 2001-2005 Five speed models.

2005 could be either five or six speed. The five speed has an external range sensor, while the six speed version has an internal range sensor.

If your has an internal range sensor, get TransGo part number SK Allison-Jr.

Working trucks – Competition – Street show off

Corrects/Prevents/Reduces:

- **Goes to neutral under high load**
- **C2 clutch failure**
- **No move forward or reverse**
- **Stuck in one gear**
- **Sets trouble codes**
- **Short crisp perfect shifts**

Boy do we love this transmission

Just looking at the hard parts pops out our eyeballs. It is also very easy to work on. All the shifts are clutch to clutch ECM controlled, and self adjust for short yet smooth shifts.

During kit development engine torque was increased to over 900 lb-ft. Then tested with 25,800 GVW on 8% grade with no trans slip, no code and no clutch damage.

Modified engines: use custom converter.

Tested to 500 horsepower



If the transmission sets codes or goes to neutral at 35 to 75 mph in 4th or 5th, the C2 clutch is probably cooked.

Listen up! This means that you should get a set of C2 frictions **before tear down**, so you won't have a stall or rack tied up waiting for clutches. Usually, everything else you need is in this kit.

Modified engine? Without this kit, more engine power usually causes codes, stuck in neutral, stuck in one gear and burned clutches.

World Champ

Made in USA



1. Enlarge the two holes shown with the large drill bit furnished (0.156") just deep enough to install the **two orifice plugs** below flush.



2. With the large drill bit furnished (0.156"), drill a hole down against the ledge as shown. **It's not fussy.**

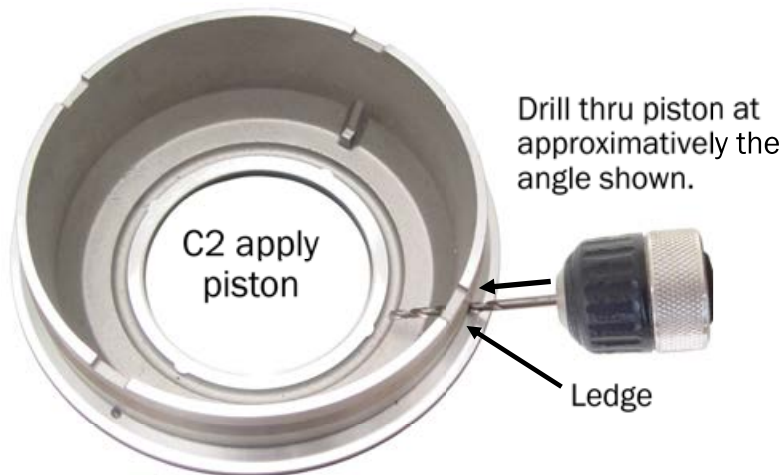

3. Separate C2 spring cage as shown. Angle old springs with 5/16 drill bit to remove them. Install the big end of the **new plain springs** over the flares in top cage, then install the bottom cage into new springs.

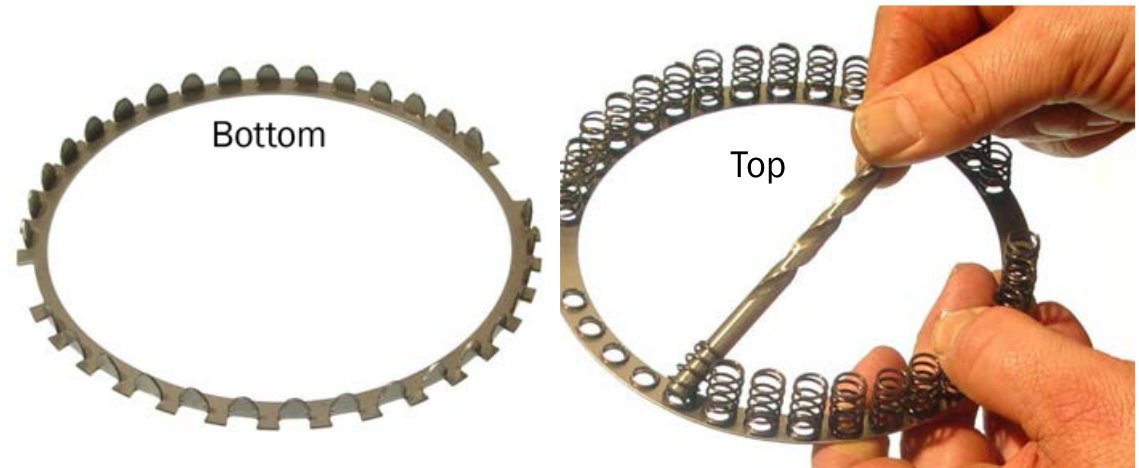

4. Assemble the rotating clutch and install into the transmission. There has been a few of these leak from bell housing bolts due to roughness in the casting. A little silicone under the bolt heads is a good idea.

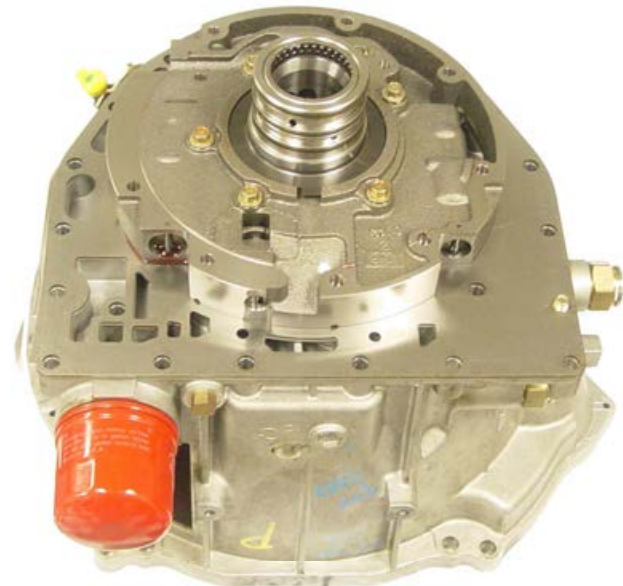

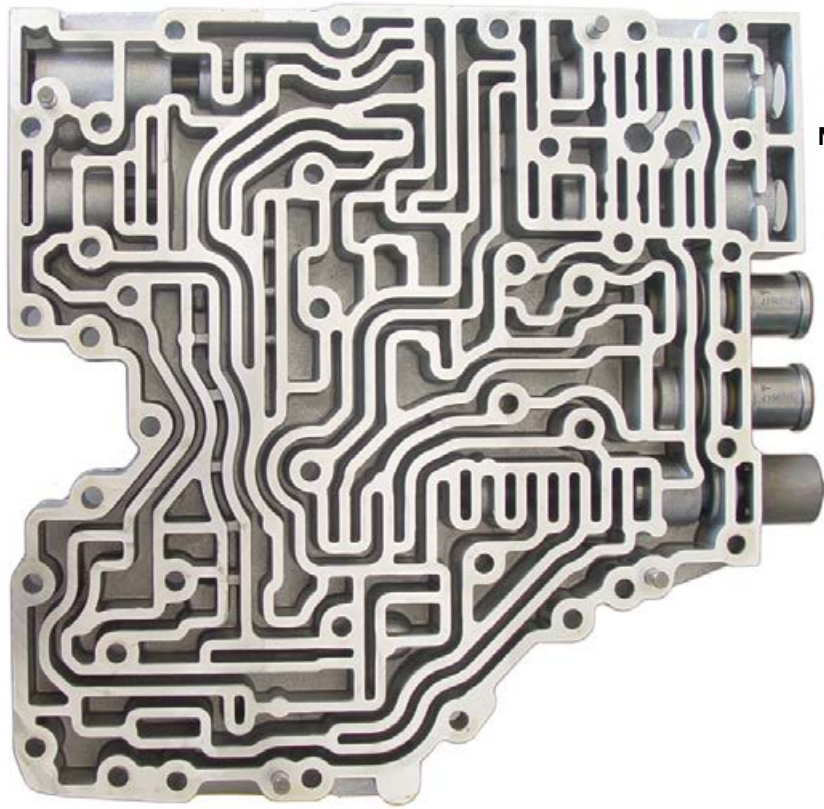

New orange spring



New plain spring

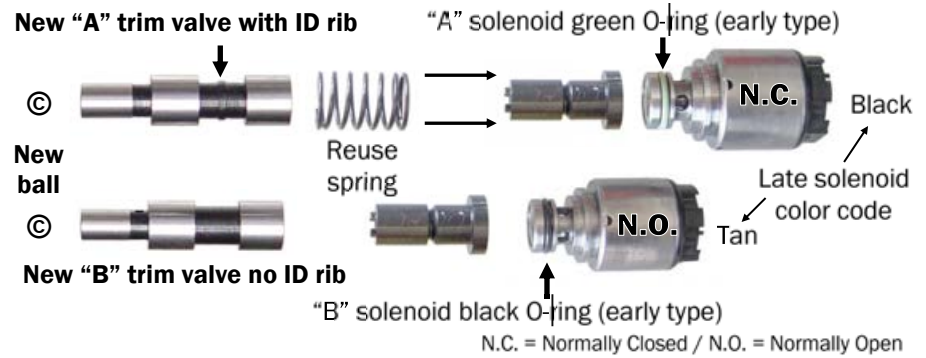

5. Discard the original trim valves and the springs on the small end. Place the **new ball** then **new small spring** into hollow end of each **new trim valves**. using assembly gel to hold them in place. Place the **new orange springs** over small end of the **new trim valves** and install them into valve body. Don't force them, a little wiggling and they will go in. Install the original "A" outer spring, solenoid valves and solenoids as shown. **The outer spring must only be installed in the "A" line up.**

Valve body and plate upgrades

To read and clear codes use scan tool and generic OBD-II software.
To read live trans data you will need a scan tool with compatible software.

To read & reset shift adaptive tables (fast learn) use Allison diagnostic software or Tech 2 scan tool.

Codes you might see:

P0731 = 1st gear slip, P0732 = 2nd gear slip, P0733 = 3rd gear slip, P0734 = 4th gear slip, P0735 = 5th gear slip, P0741 = TCC slip

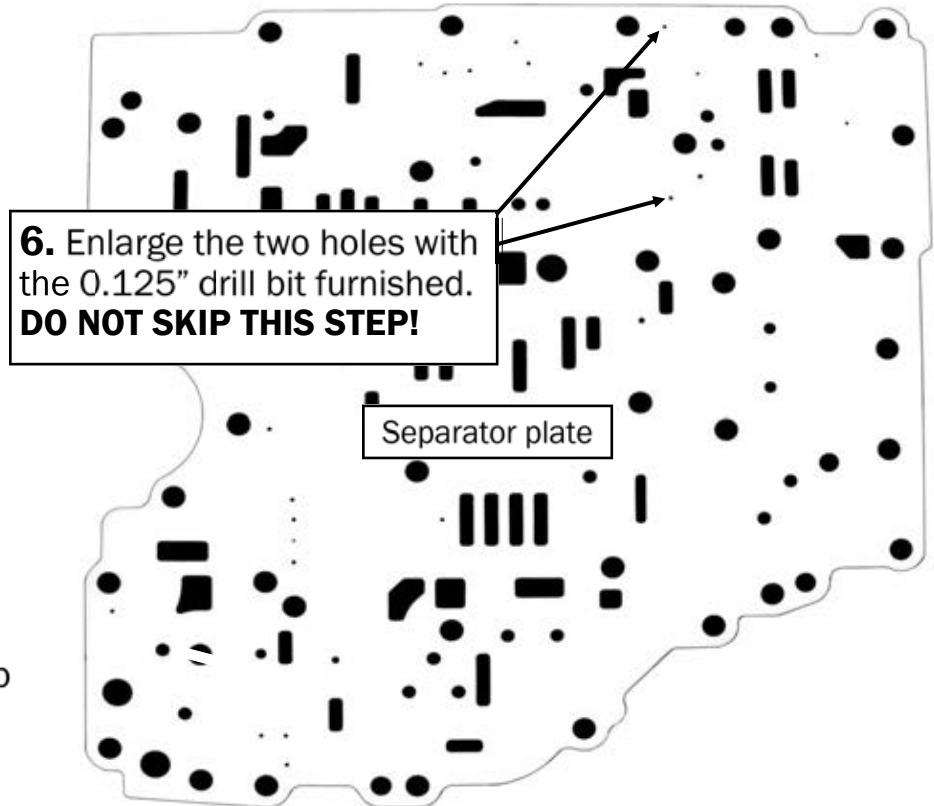

These 2 switches were deleted on late type pressure switch assy.

Valve body reassemble

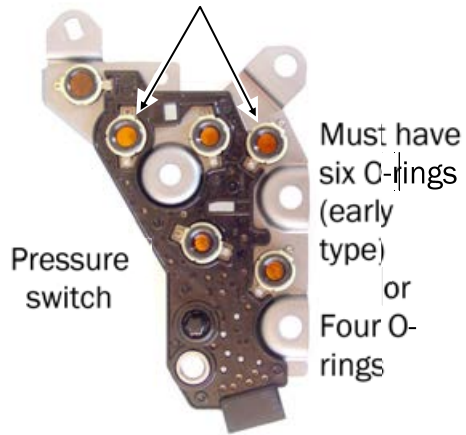

Accumulators install first hollow end out, then springs.

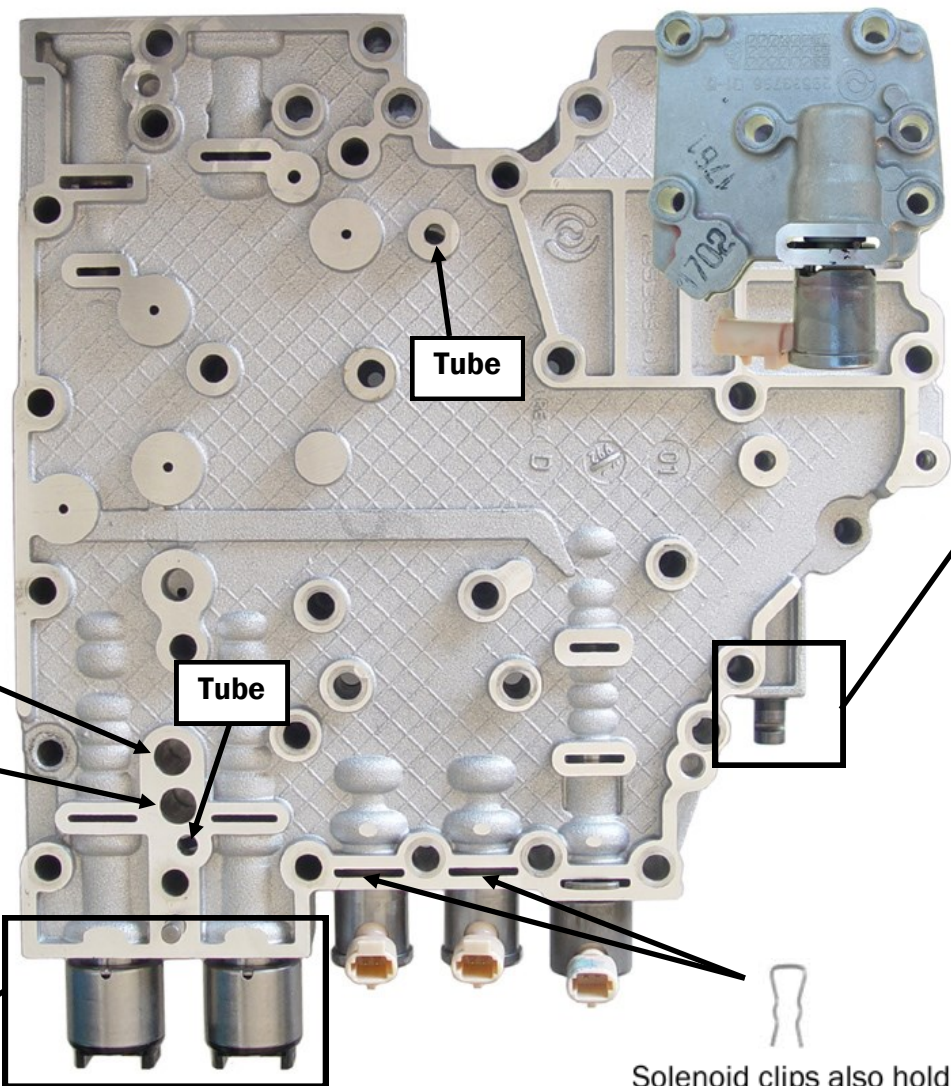

Valve body viewed from back side

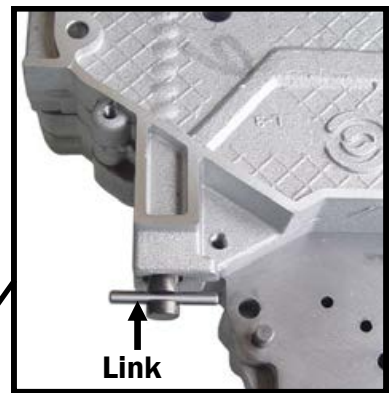

Place link into groove, slide valve into the valve body to hold it in place.



Push the solenoids firmly into the valve body when installing solenoid bracket.

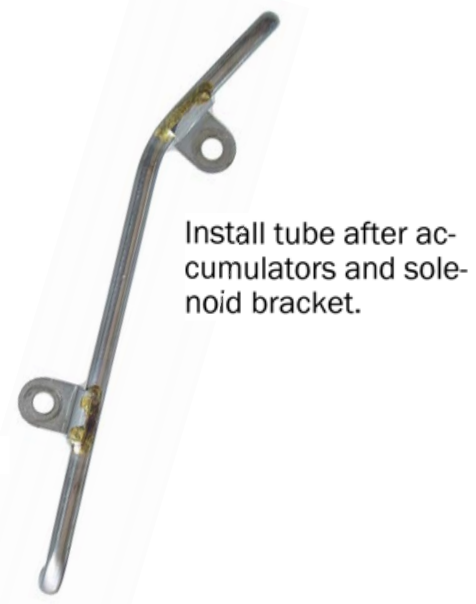

Relearn is required when adding horsepower or working on the trans: This trans is a tough piece, with intelligent computer control. The computer has adaptive strategy that constantly adjusts shift clutch pressures to match engine torque and vehicle load. With increased horsepower, you must allow time for relearning.

Start relearn by making at least six sets of light throttle upshifts through all gears. Next, make six sets of shifts at 1/3 throttle, then 1/2 throttle, 3/4 throttle, and so on. Treat downshifts the same way by starting with light throttle and working up to full throttle. When the shifts are quick and smooth, hit the tow haul button and start over with the relearn.

During the relearn expect some clunks, bumps and or short flares, especially during the 3-4 shift. Bumps and flares are normal during the relearn. **Always do relearn** with any power change or when there has been any repair or change in the pump, valve body or clutches. **Installation of the TransGo Shift Kit® requires relearn.**

Explanation: The computerized control system on this truck is watching and recording everything, it stores data in lookup tables similar to a spread sheet. For example how long, in time, it takes for a gear change to complete under various conditions. It looks at and records the relationship between rate of acceleration and throttle opening, it calculates the engine torque output based on inputs like fuel consumption, boost pressure, air density, temperature, throttle position, and many other factors. It then uses this to calculate the load or weight that is being accelerated at a given time. **It learns and remembers.**

All this information is used by the computer to calculate the optimum gear change apply rate.

A perfect shift is as short, in time, as possible with minimum feel and stress to the drivetrain.

For every gear change the computer system must release one gear and bring on the next. If the release and apply is too slow for a given torque and load, a cut loose / slipping will occur.

If release is too slow or apply too quick a bind up will occur — two gears at the same time.

Both of these conditions can cause major damage — clutch failure.

Relearn usually takes about 2 hours. This can be greatly reduced by using Tech 2 or PC based Allison software to clear memory and place the TCM in the fast learn mode.

Give this transmission respect and it will give you appreciation and service.

“Thanks for listening”

TransGo tech team

2001-2003 Drain Back and Pump Prime Kit

2004-Up Skip This Page

Step 1. With bell housing off the trans, remove 10 Bolts in the bell housing, these bolts have O-rings under bolt heads.



These upgrades reduce loss of pump prime, due to drain back, after long period of non-use.

Retainer installs here **after** TCC limit valve and spring.

Step 3. Discard original springs. Install **New Orange** and **White** springs as shown.

Step 2. Remove 5 Bolts from rear. Lift off stator and flip it over.

TCC Limit and Lube regulator were redesigned in 2004
No change needed.

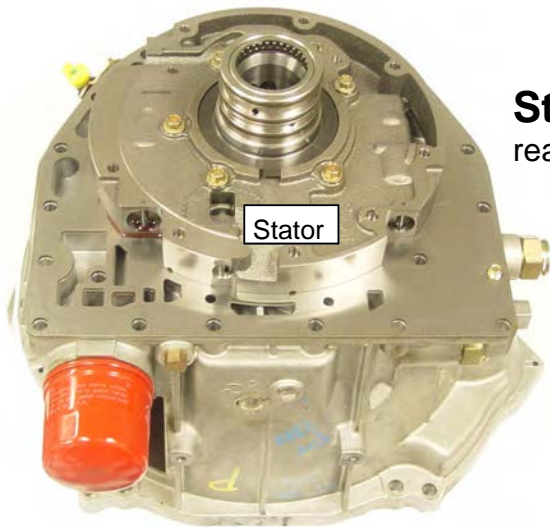
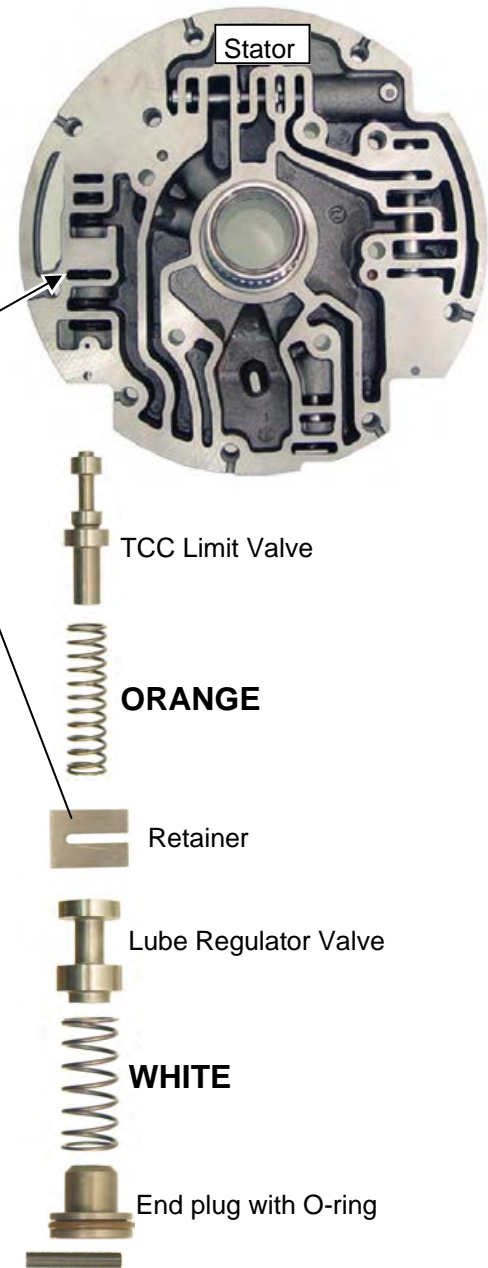

A1-Spr-Park Allison Park Spring

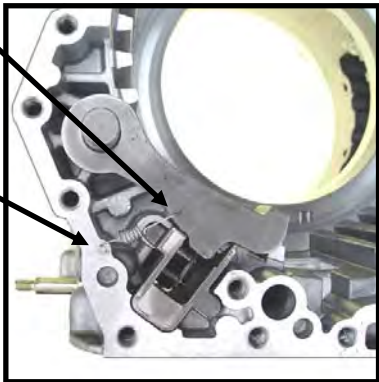

Contents
A1-Pawl-31
A1-Pin-Park

If the extension housing has been removed the park pawl spring is usually damaged. This upgrade will help. Gil

This will prevent misaligning main shaft when removing front end.
Assembly: The factory recommendation for bell-housing bolts is 45 ft lbs.

Remove Bolts ®

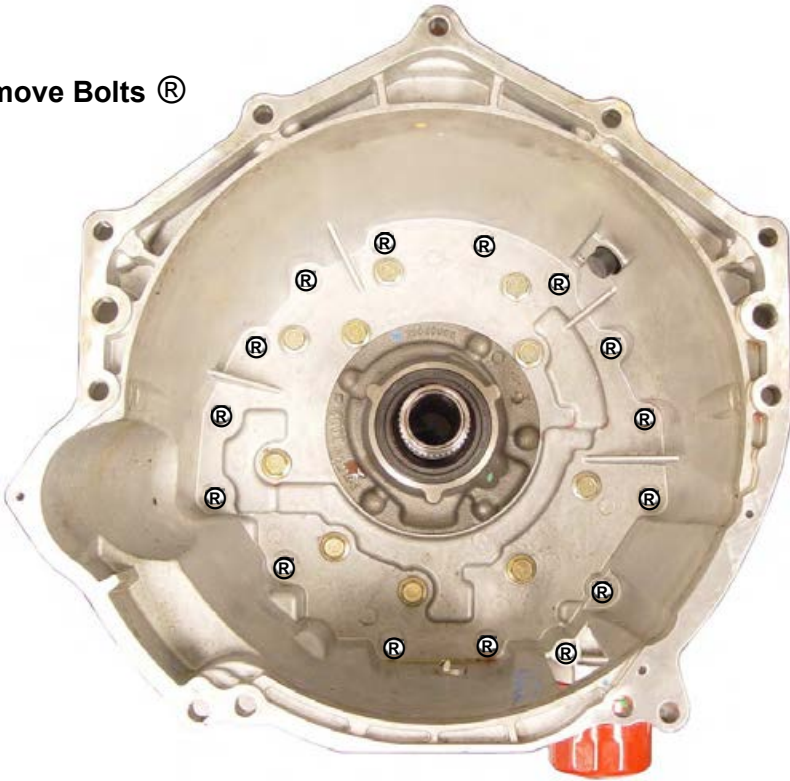

Remove five outside bell-housing bolts.

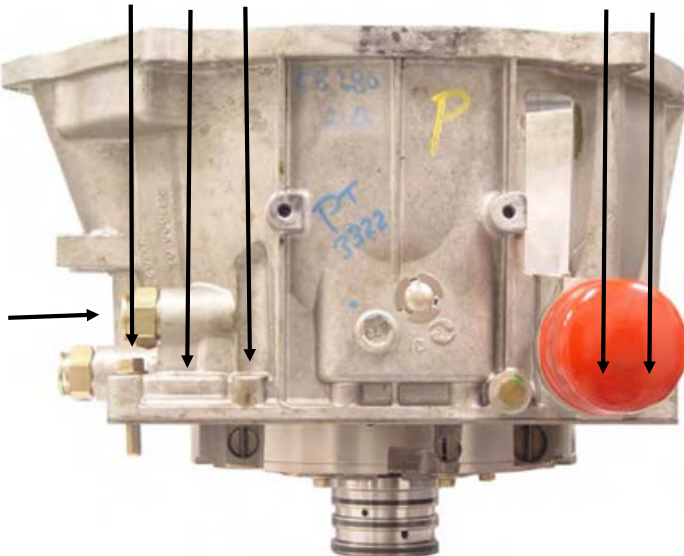

Removing lower cooler fitting makes this easy.

Lower
Fitting



"It was lots of work, but also a joy and honor upgrading this trans to stay together in Hot Rods and Hi-load uses. Brutally tough, but not rough--Perfect."

Mr Shift ®

Removing Clutch Drum: Wiggle, rock, and rotate input shaft and drum clockwise while removing to insure the main shaft does not lift up or move forward.

Don't lift up, pull or rotate Main Shaft. If it is pulled forward or lifted up a lube hole could be misaligned.

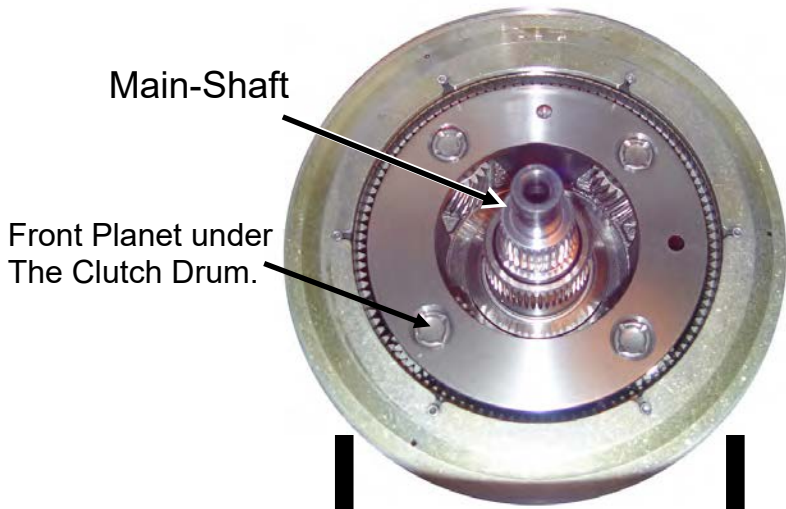
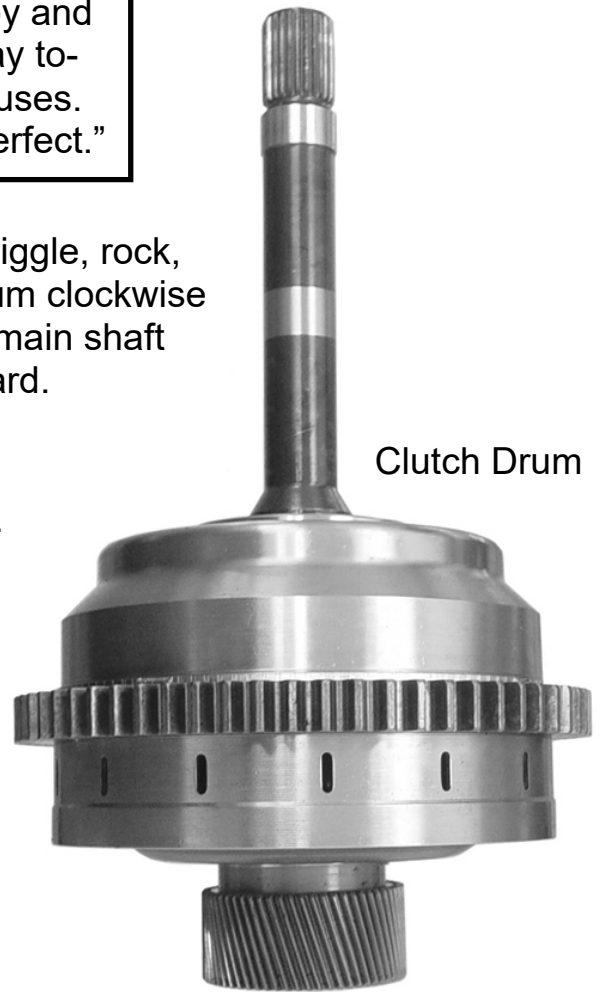

Case: With Oil Pan and Filter Removed.

After a few years of service wiring gets brittle. **Carefully** disconnect all electrical from VB.

Remove ® bolts. After ® bolts are out wiggle VB to lift it off of the dowels.

Long gold bolt here.

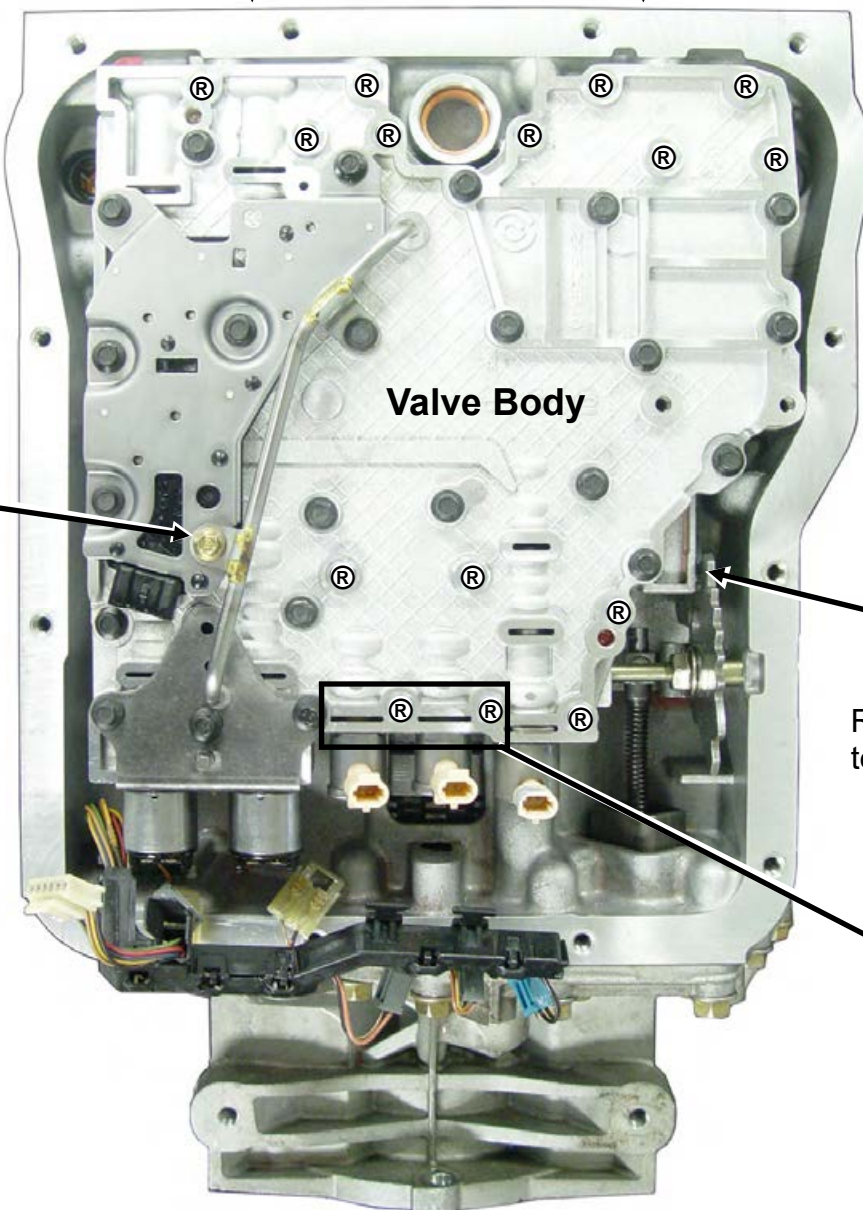

Careful not to loose manual valve link when removing VB.

Remove two solenoid clips to remove harness from VB.

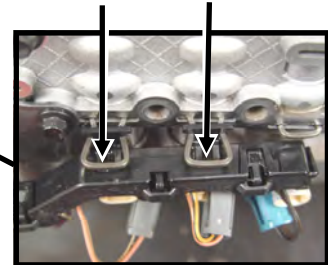



Disassemble Clutch Drum
C2 apply piston and spring cage will be upgraded during Shift Kit® installation.

Input Shaft

Step 2 Install input shaft into clutch drum from front side. Install input shaft snap ring from rear of drum.

Clutch Drum

Step 4 Install C1 clutch plates then backing plate and snap ring. Then install spiral ring while lifting up on backing plate.



C1 Clutch Plates C1 Backing Plate

C1 Clutch Hub



Step 5 Wiggle C1 clutch hub down over C1 plates, Place large bearing on C1 hub open side against hub.



Step 6 Assemble parts in order shown



C2 Clutch Hub C2 Clutch Plates C2 Backing Plate

Step 1 Reassemble parts in order shown

Page 2

C2 Apply Piston

C2 Balance Piston

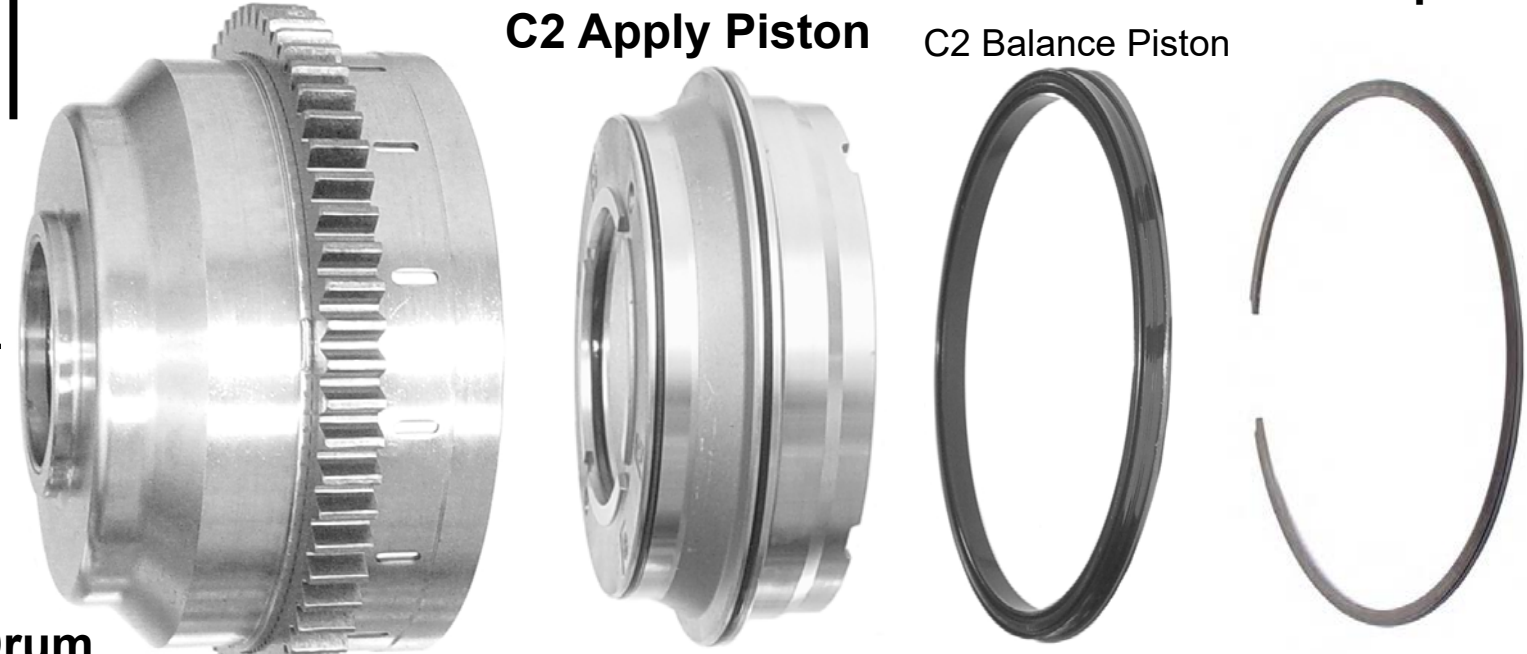

C2 Spring Cage



C1 Piston Housing



C1 Apply Piston



C1 Spring Cage



C1 Balance piston



Step 3 Install small bearing this side down into recess in input shaft.



Step 2 Install input shaft snap ring.