



INSTALLATION GUIDE

PART NUMBER: 25009

FRONT LOWERING STRUT

NISSAN TITAN 2WD / 4WD | 2004-2015

NISSAN ARMADA 2WD / 4WD | 2004-2015

0" TO -2" HEIGHT ADJUSTABLE LOWERING

300 W. PONTIAC WAY. CLOVIS, CA 93612

PHONE: 800-445-3767 | EMAIL: INFO@BELLTECH.COM

THANK YOU

Thank you for choosing our high quality Belltech product. We have spent a great deal of time developing our line of products so that you will receive maximum performance with minimal difficulty during installation. Soon your vehicle will be on the road looking and feeling much improved.

Please take a moment to read all instructions and warnings prior to installation of your new Belltech product and before operating your vehicle. If you have any questions or concerns regarding any step in the installation process, please do not hesitate to call or email our customer support specialists who are trained to help you through any portion of this process.

Before You Begin:

It is of the utmost importance that you confirm all of the components listed on the parts list is in the kit. You can find this list located on the last page(s) of your instructions. Do not begin installation if any part is missing. Instead, please call our Belltech customer service specialists.

Belltech Customer Support:

Phone: 1-800-445-3767

Email: info@belltech.com

Safety Information:

Warning: Do not work under a vehicle supported only by a jack. Place support stands securely under the vehicle in the manufacturer's specified locations unless otherwise instructed.

Proper use of safety equipment and eye/face/hand protection is absolutely necessary when performing any of the following instructions.

We strive for an exceptional experience for all our valued customers. If for any reason you need assistance with your Belltech products, please do not return the product to the store you purchased from, but rather call our dedicated customer service experts, from 7am to 5pm PST.

We recommend that a qualified mechanic, at a properly equipped facility, perform this installation.

It is very helpful to have an assistant available during installation.

Before Driving Your Vehicle:

It is important to double check all brake hoses, cables, and other components to be sure there is no interference. You must also check for wheel/tire to chassis/body interference. If any issues are found, review your installation instructions to be sure no steps were missed and any problems are corrected.

Make sure your vehicle is aligned immediately following installation.

Check all hardware and re-torque at intervals for the first 10, 100, and 1000 miles.

Some of Belltech's products are designed to improve your vehicle's off-road performance. Leveling/lifting your vehicle may result in an altered center of gravity. It is crucial to use extreme care when operating your vehicle to prevent rollover and/or loss of control.

Any changes in your vehicle's suspension may result in transformed handleability. Please test-drive your vehicle in a remote location so you can become accustomed to the revised driving characteristics.

Perform headlight check and adjustment.

Failure to drive any modified vehicle in a safe manner may result in harm or death.

Never operate your modified vehicle under the influence of drugs, alcohol, or lack of adequate sleep.

Always wear your seatbelt.



DIFFICULTY:

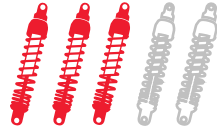

INSTALLATION TIME:

2-4 Hours + Alignment

RECOMMENDED TOOLS:

- Properly rated floor jack
- Support stands
- Wheel chocks
- Metric socket wrench set
- Tape measure
- Marking pen
- Safety glasses

SPECIALTY TOOLS:

- High quality spring compressor
- Torque wrench up to 150 ft lbs.
- Dead-blow hammer

INSTALLATION PREPARATION:

Before beginning the installation process, measure the hub to fender heights for your vehicle and record them in the “Before” section. After your vehicle has been modified, record the new measurements in the, “After” section. This way, you can compare the resulting height to the original. When taking the measurements, measure vertically from the center of the wheel to the inner edge of the fender.

Before:

LF: _____

RF: _____

LR: _____

RR: _____



After:

LF: _____

RF: _____

LR: _____

RR: _____

JACKING, SUPPORTING, AND PREPARING THE VEHICLE

1. Park your vehicle on a smooth, level, concrete or seasoned asphalt surface.
2. Block the rear wheels of the vehicle using wheel chocks. Make sure the vehicle's transmission is in "PARK" (automatic) or 1st gear (manual).
3. Activate the parking brake.
4. Break loose, but do not spin the wheel lug nuts to ease in removal when the wheels are in the air.
5. Lift the front of the vehicle off the ground using a properly rated floor jack. Lift the vehicle so the front tires are approximately 6-8 inches off the ground.
6. Place support stands rated for the vehicles weight. The stands should be positioned in the factory specified locations (Refer to the owners manual). Prior to lowering the vehicle onto stands, make sure the support stands will contact the chassis. It is very important that the vehicle is properly supported to prevent any harm to ones self or to the vehicle.
7. Lower the vehicle slowly onto the stands.
8. Remove the front wheels.



Technician reminder:

Never work under a vehicle supported only by a jack. It is necessary to place support stands securely under the vehicle in the manufacturer's specified locations unless otherwise instructed.

OEM STRUT REMOVAL

9. Remove the 21mm ball joint nut from the outer tie-rod. Strike the spindle with a dead-blow hammer to dislodge the outer tie-rod.
10. Remove the 17mm lower end link nut to detach the end link from the lower control arm. Swing the sway bar away from the lower control arm.



Technician reminder:

If needed, use a 19mm open end wrench to hold the end link stud from spinning.

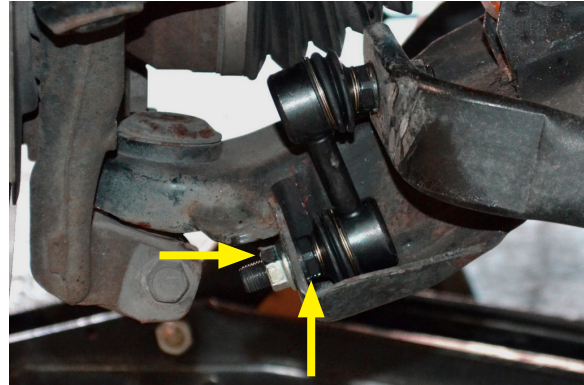

11. Remove the 19mm lower strut mount nut and bolt from the lower control arm.



11. Remove the three 14mm top mount nuts that hold the strut to the chassis.



12. Hold the spindle assembly while pushing down to dislodge and remove the strut assembly from the upper and lower mounts. During the removal of the strut, ensure not to damage the brake and ABS lines.

OEM STRUT DISASSEMBLY

- Using a proper spring compressor, mount the strut assembly and ensure it is secured before proceeding. To ease the installation of the new strut, mark the position of the top mount in relationship to the upper spring isolator and strut body. Compress the spring until tension is relieved from the strut.



Technician note:

The coil spring is held in place under extreme compression. **Belltech** recommends the use of a heavy-duty spring compressor suitable for truck springs to perform the following steps. If unsure of your spring compressor capabilities, please take your struts to a professional installer. Use caution during the following steps to avoid personal injury and/or damage to the vehicle.

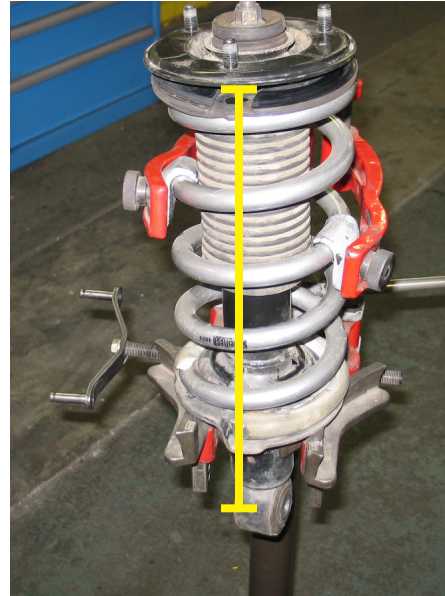

- Using a 19mm wrench remove the top nut from the strut assembly (DO NOT USE AN IMPACT GUN). Remove the top nut and mount. You will use the original top mount and rubber isolator with your new Belltech strut later.



Technician reminder:

The strut will need to be supported to prevent it from falling when the nut is removed.



- Remove the strut from the compressed spring fixture.

BELLTECH STRUT ASSEMBLY

16. The strut is delivered as shown below. Remove the Nyloc nut from the top of the Belltech strut to proceed.



Technician note:

When lowering your vehicle more than 1", OE camber may not be achievable. After installation a final shop alignment procedure is recommended to minimize tire wear.

17. Using the tables below as reference, add the needed lift rings to reach the desired height.

2004-2015 TITAN / ARMADA 2WD / 4WD		
Drop (Inches)	7mm Ring Spacer	14mm Ring Spacer
+2"	2	3
+1"	0	3
0"	0	2
-1"	0	1
-2"	0	0

18. Install the spring perch over the lift rings onto the strut. Do not install the spring perch upside down.



BELLTECH STRUT ASSEMBLY CONTINUED



Ventilation Disk Installation Warning:

When assembling the Belltech shock/strut, make note of the orientation of the supplied Belltech ventilation disk. It has two sides: a flat side and an air-channeled side. The air-channeled side **MUST** be facing downward toward the shock/strut and the flat side toward the bump stop (See figures 1A and 1B).

Failure to do this, will result in shock/strut damage.

19. Slide the vent disk on the strut rod. Ensure the air-channeled side facing down as shown in the images below.

**Air-channels face
down toward strut**

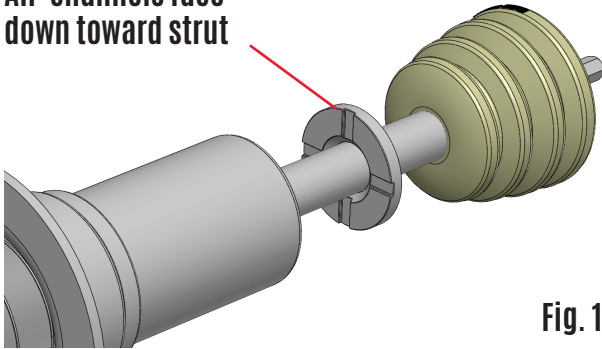

Fig. 1A

**Flat surface faces up
toward bump stop**

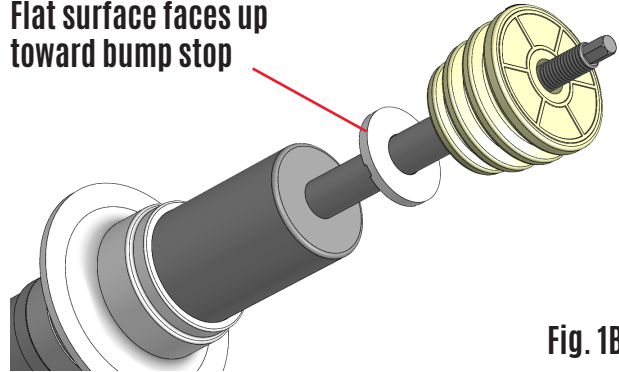
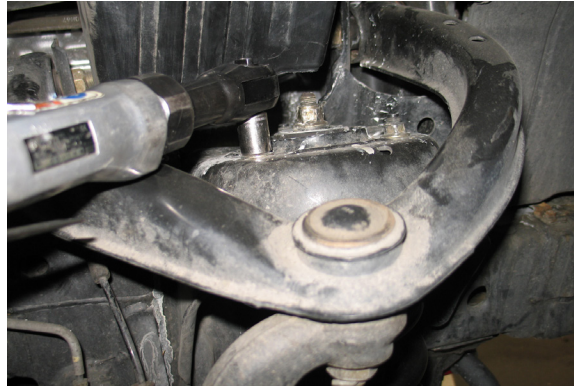

Fig. 1B

20. With the OEM spring still compressed, slide the new Belltech strut into the OEM spring and install Belltech bump stop on the strut rod.
21. Complete the assembly using the OEM spring isolator, top mount, and supplied Nyloc nut.
22. Align the top mount with the spring using the original marking made in step 13. Torque the strut rod nut to 40 ft lbs.

BELLTECH STRUT INSTALLATION

23. Place the strut assembly in the strut tower on the chassis. Secure the strut with the three top mount nuts. Torque to 22 ft lbs.



24. Attach the lower strut mount using the original nut and bolt on the lower control arm. Torque to 99 ft lbs.



Technician note:

It may be necessary to use a jack and lift the lower control arm assembly to help line up the lower shock mount with the lower control arm mount.



25. Attach the lower end link to the lower control arm. Torque the nut to 14 ft lbs.

26. Attach the outer tie-rod to the spindle. Torque the ball joint nut to 63 ft lbs.

FINALIZING THE INSTALLATION

27. Mount the wheels and tighten the lug nuts.
28. Lift the vehicle and remove the support stands.
29. Carefully lower the vehicle onto the flat ground.
30. Torque the lug nuts to 98 ft lbs.
31. Check that all components and fasteners have been properly installed and torqued.
32. Read and perform all tasks in the “Before Driving Your Vehicle” section of page 1 of your instructions.

THANK YOU FOR CHOOSING BELLTECH.

You are now a part of the Belltech family and we are eager to catch a glimpse of your newly modified vehicle. Give us a shout out and let us know how much you love our product. Don't forget, we offer other Belltech related merchandise for you and your vehicle on our website www.belltech.com

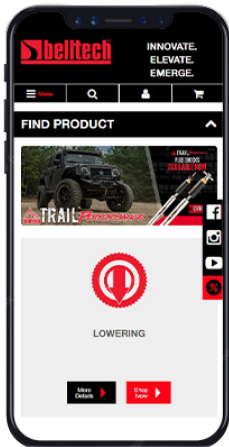

[belltechsuspension](https://www.facebook.com/belltechsuspension)



[Belltech Suspension](https://www.youtube.com/BelltechSuspension)



[@belltechsuspension](https://www.instagram.com/belltechsuspension)

If you have any questions, concerns, or warranty related issues regarding your Belltech product, please call or email our experienced customer service specialists.

Belltech Customer Support:

Phone: 1-800-445-3767

Email: info@belltech.com

KIT CONTENTS



25009		
Part number	Description	Qty
25009-200	BELLTECH LOWERING STRUT	1
NUT	NYLOC NUT M12X 1.25	1
25009-004	SPRING PERCH	1
65210031	VENT DISK	1
4928-001	BUMP STOP	1
25003-007	7MM SPACER	3
25003-014	14MM SPACER	3