



# INSTALLATION GUIDE

**PART NUMBER: 25019**

**FRONT LOWERING STRUT**

**GM 1500 TRUCK 2WD / 4WD | 2019+**

**GM 1500 SUV 2WD / 4WD | 2021+**

0" TO -3" HEIGHT ADJUSTABLE LOWERING

300 W. PONTIAC WAY. CLOVIS, CA 93612

PHONE: 800-445-3767 | EMAIL: [INFO@BELLTECH.COM](mailto:INFO@BELLTECH.COM)

# THANK YOU

Thank you for choosing our high quality Belltech product. We have spent a great deal of time developing our line of products so that you will receive maximum performance with minimal difficulty during installation. Soon your vehicle will be on the road looking and feeling much improved.

**Please take a moment to read all instructions and warnings prior to the installation of your new Belltech product and before operating your vehicle. For any questions or concerns regarding the steps in the installation process, please do not hesitate to call or email our customer support team who are trained to help you through any portion of this process.**

## Before You Begin:

**It is of the utmost importance that you confirm all of the components listed on the parts list is in the kit. You can find this list located on the last page(s) of your instructions. Do not begin installation if any part is missing. Instead, please call our Belltech customer service specialists.**

### Belltech Customer Support:

**Phone: 1-800-445-3767**

**Email: [info@belltech.com](mailto:info@belltech.com)**

## Safety Information:

**Warning:** Do not work under a vehicle supported only by a jack. Place support stands securely under the vehicle in the manufacturer's specified locations unless otherwise instructed.

Proper use of safety equipment and eye/face/hand protection is absolutely necessary when performing any of the following instructions.

We strive for an exceptional experience for all our valued customers. If for any reason you need assistance with your Belltech products, please do not return the product to the store you purchased from, but rather call our dedicated customer service experts, from 7am to 5pm PST.

We recommend that a qualified mechanic, at a properly equipped facility, perform this installation.

It is very helpful to have an assistant available during installation.

## Before Driving Your Vehicle:

It is important to double check all brake hoses, cables, and other components to be sure there is no interference. You must also check for wheel/tire to chassis/body interference. If any issues are found, review your installation instructions to be sure no steps were missed and any problems are corrected.

Make sure your vehicle is aligned immediately following installation.

Check all hardware and re-torque at intervals for the first 10, 100, and 1000 miles.

Some of Belltech's products are designed to improve your vehicle's off-road performance. Leveling/lifting your vehicle may result in an altered center of gravity. It is crucial to use extreme care when operating your vehicle to prevent rollover and/or loss of control.

Any changes in your vehicle's suspension may result in transformed handleability. Please test-drive your vehicle in a remote location so you can become accustomed to the revised driving characteristics.

Perform headlight check and adjustment.

Failure to drive any modified vehicle in a safe manner may result in harm or death.

Never operate your modified vehicle under the influence of drugs, alcohol, or lack of adequate sleep.

Always wear your seatbelt.



**DIFFICULTY:**

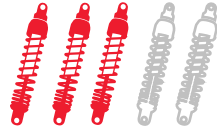

**INSTALLATION TIME:**

2-4 Hours + Alignment

## RECOMMENDED TOOLS:

- Properly rated floor jack
- Support stands
- Wheel chocks
- 1/2" or 3/8" drive wrench
- Metric socket wrench set
- Metric wrench set
- Tape measure
- Marking Pen

## SPECIALTY TOOLS:

- High quality spring compressor
- Torque wrench up to 200 ft lbs

## FITMENT NOTE:

**This Belltech Strut does NOT fit Models with ARC or Magnetic Ride Shocks.**

**Lowering Chevy Trail Boss / GMC Elevation models with the 2" factory lift will result in further lowering than advertised compared to standard GM 1500 trims.**

## INSTALLATION PREPARATION:

Before beginning the installation process, measure the hub to fender heights for your vehicle and record them in the "Before" section. After your vehicle has been modified, record the new measurements in the, "After" section. This way, you can compare the resulting height to the original. When taking the measurements, measure vertically from the center of the wheel to the inner edge of the fender.

**Before:**

LF: \_\_\_\_\_

RF: \_\_\_\_\_

LR: \_\_\_\_\_

RR: \_\_\_\_\_

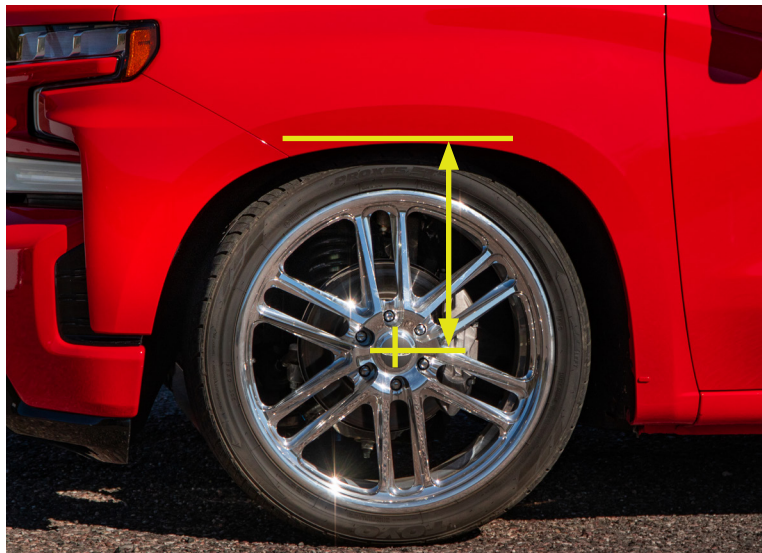

**After:**

LF: \_\_\_\_\_

RF: \_\_\_\_\_

LR: \_\_\_\_\_

RR: \_\_\_\_\_

# JACKING, SUPPORTING, AND PREPARING THE VEHICLE

1. Park your vehicle on a smooth, level, concrete or seasoned asphalt surface.
2. Block the rear wheels of the vehicle using wheel chocks. Make sure the vehicle's transmission is in "PARK" (automatic) or 1st gear (manual).
3. Activate the parking brake.
4. Break loose, but do not spin the wheel lug nuts to ease in removal when the wheels are in the air.
5. Lift the front of the vehicle off the ground using a properly rated floor jack. Lift the vehicle so the front tires are approximately 6-8 inches off the ground.
6. Place support stands rated for the vehicles weight. The stands should be positioned in the factory specified locations. (Refer to the owners manual). Prior to lowering the vehicle onto stands, make sure the support stands will contact the chassis. It is very important that the vehicle is properly supported to prevent any harm to ones self or to the vehicle.
7. Lower the vehicle slowly onto the support stands.
8. Remove the front wheels.



## Technician reminder:

Never work under a vehicle supported only by a jack. It is necessary to place support stands securely under the vehicle in the manufacturer's specified locations unless otherwise instructed.

## OEM STRUT REMOVAL

9. Locate the three mounting bolts at the top of the strut. Remove the nuts using an 18mm wrench.

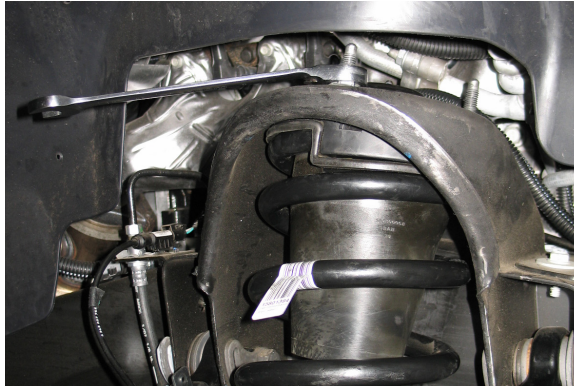

10. Remove the bottom bolts on the OE strut and lower control arm using a 15mm wrench.

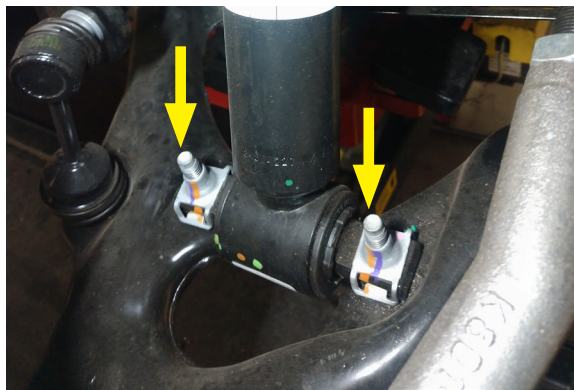

11. Remove the mounting nut holding the anti-sway bar end link to the lower control arm. The nut is located on the underside of the lower control arm. This will allow the lower control arm to swing down and ease the removal of the strut.



12. Push or pry down on the lower control arm to gain clearance and remove the strut.

## OEM STRUT DISASSEMBLY

- Using a proper spring compressor, mount the strut assembly and ensure it is secured before proceeding. To ease the installation of the new Belltech strut, mark the position of the top mount in relationship to the upper spring isolator and strut body.



### Technician note:

The installation photograph shown was taken at a professional installation shop. It is important to use a spring compressor to compress the spring before removing the top mount bolt. Failure to do so may result in serious injury.

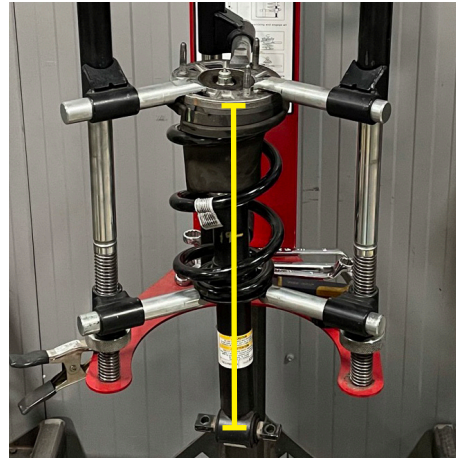

- Compress the spring until tension is relieved from the strut. Remove top nut and mount. You will use the mount with your new Belltech strut.
- Remove the spring and strut from the fixture.
- Separate the top mount from the spring isolator using a pry tool or flat head screw driver.



# BELLTECH STRUT ASSEMBLY

17. The strut is delivered as shown below. Remove the Nyloc nut from the top of the Belltech strut to proceed.



## Technician note:

When lifting your vehicle more than 1", OE camber may not be achievable. After installation a final shop alignment procedure is recommended to minimize tire wear.

18. Using the tables below as reference, add the needed lift rings to reach the desired height.

2019+ GM 1500 2WD		
Drop (Inches)	7.5mm Ring	15mm Ring
0"	1	3
1"	1	2
2"	1	1
3"	1	0

2019+ GM 1500 4WD		
Drop (Inches)	7.5mm Ring	15mm Ring
0"	0	4
1"	0	3
2"	0	2
3"	0	1

19. Install the spring perch onto the strut. Do not install the spring perch upside down.

## BELLTECH STRUT ASSEMBLY CONTINUED



### Ventilation Disk Installation Warning:

When assembling the Belltech shock/strut, make note of the orientation of the supplied Belltech ventilation disk. It has two sides: a flat side and an air-channeled side. The air-channeled side **MUST** be facing downward toward the shock/strut and the flat side toward the bump stop (See figures 1A and 1B).

Failure to do this, will result in shock/strut damage.

20. Slide the vent disk on the strut rod. Ensure the air-channeled side facing down as shown in the images below.

**Air-channels face  
down toward strut**

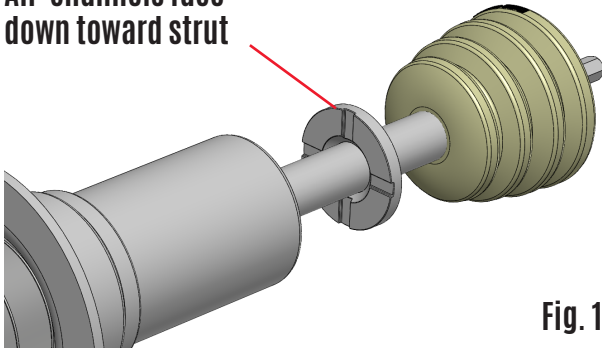

**Fig. 1A**

**Flat surface faces up  
toward bump stop**

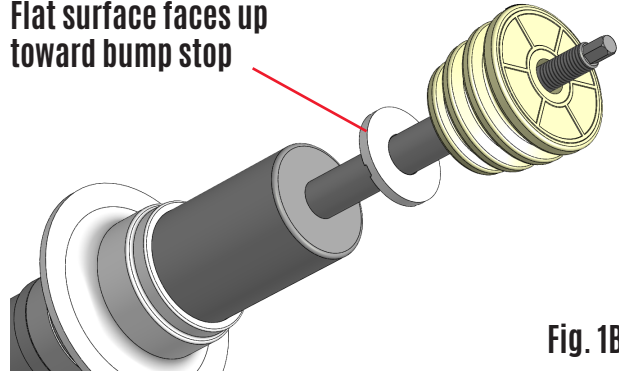

**Fig. 1B**

21. With the OEM spring still compressed, slide the new Belltech strut into the OEM spring and install Belltech bump stop on the strut rod.
22. Complete the assembly using the OEM spring isolator, top mount, and supplied Nyloc nut.
23. Align the top mount with the spring using the original marking made in step 13. Torque the strut rod nut to 37 ft lbs.



# STRUT INSTALLATION

24. Reinstall the new strut assembly in reverse order of disassembly. If new hardware was not supplied, use the OEM nuts and bolts to fasten the strut to the chassis.
25. Install the top mount into the chassis and secure it using the three OEM nuts. Torque the nuts to 43 ft lbs.



## Technician reminder:

Torque to specs with the weight of the vehicle on the suspension or with the suspension loaded through the use of a jack.



26. Attach the lower strut mount to the lower control arm with the two OEM bolts and torque to 37 ft lbs.



27. Attach the end link to the lower control arm, torque to 74 ft lbs. when the suspension is loaded or the vehicle is back on the ground.

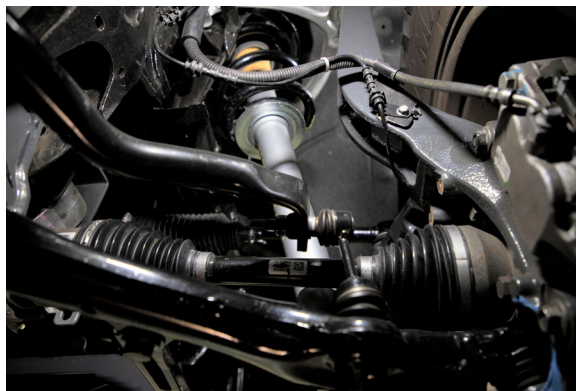

# FINALIZING THE INSTALLATION

28. Mount the wheels and tighten the lug nuts.
29. Lift the vehicle and remove the support stands.
30. Carefully lower the vehicle onto the flat ground.
31. Torque the lug nuts to 140 ft lbs.
32. Check that all components and fasteners have been properly installed and torqued.
33. Read and perform all tasks in the “Before Driving Your Vehicle” section of page 1 of your instructions.

## THANK YOU FOR CHOOSING BELLTECH.

You are now a part of the Belltech family and we are eager to catch a glimpse of your newly modified vehicle. Give us a shout out and let us know how much you love our product. Don't forget, we offer other Belltech related merchandise for you and your vehicle on our website [www.belltech.com](http://www.belltech.com)

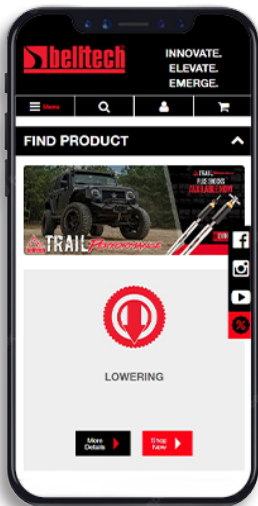

belltechsuspension



Belltech Suspension



@belltechsuspension

If you have any questions, concerns, or warranty related issues regarding your Belltech product, please call or email our experienced customer service specialists.

### Belltech Customer Support:

Phone: 1-800-445-3767

Email: [info@belltech.com](mailto:info@belltech.com)

# KIT CONTENTS



25019		
Part number	Description	Qty
25019-200	BELLTECH LIFTING STRUT	1
25003-015	15MM LIFT RING	4
25003-075	7.5MM LIFT RING	1
NUT	M12 x 1.25MM FLANGED NYLOC NUT	1
4926-001	BUMP STOP	1
65210031	VENT DISC	1
25003-002	SPRING PERCH	1