



INSTALLATION INSTRUCTIONS

152501 KITS

6-7" LIFT KIT

300 W. Pontiac Way Clovis, CA 93612 toll free: 1-800-445-3767 web: www.belltech.com

2015-2020 Ford F150 4WD 6-7" Lift Kit

Thank you for being selective enough to choose our high quality BELLTECH PRODUCT. We have spent many hours developing our line of products so that you will receive maximum performance with minimum difficulty during installation

Note: Confirm that all of the hardware listed in the parts list is in the kit. **Do not** begin installation if any part is missing. Read the instructions thoroughly before beginning this installation.

Warning: DO NOT work under a vehicle supported by only a jack. Place support stands securely under the vehicle in the manufacturer's specified locations unless otherwise instructed.

Warning: DO NOT drive vehicle until all work has been completed and checked. Torque all hardware to specified values.

Reminder: Proper use of safety equipment and eye/face/hand protection is absolutely necessary when using these tools to perform procedures!

Note: It is very helpful to have an assistant available during installation.

Note: Please refer to component and hardware list before beginning installation to insure all necessary pieces have been supplied and packaged.

Warning: Not all possible wheel sizes and backspacing can be tested. Cautiously check wheel assembly to spindle, suspension component, and fender/body clearance before tightening lug nuts and rotating the wheel assembly. Belltech is not responsible for any wheel, tire, suspension component, and/or body damage caused by failure to check for interference.

Exceptional Customer Experience Guarantee:

STOP! We strive for an exceptional experience for all of our valued customers. If, for any reason, you need assistance with your Belltech products, please do not return the products to the store or website you purchased from. Please call our dedicated experts at (1-800-445-3767) from 6am to 5pm PST.

RECOMMENDED TOOLS:

- Properly rated floor jack and support stands
- Wheel chocks
- Torque wrench up to 200 ft/lbs range
- Metric socket wrench set
- Metric wrench set
- Metric hex key set
- Tape measure
- Dead blow hammer
- Marking pen
- Safety Glasses
- Reciprocating Saw and/or Angle Grinder with metal cutting blades



DIFFICULTY:



INSTALLATION TIME: 6-8hrs + Alignment

1) KIT PREPERATION

- a) Before beginning the install process, measure the hub to fender heights for your vehicle so you can compare the resulting height to the original. Measure vertically from the center of the wheel to the inner edge of the fender. Record the results here:

LF: _____ RF: _____ LR: _____ RR: _____

- b) Park the vehicle on a smooth, level concrete or seasoned asphalt surface and activate the parking brake. Block the rear wheels of the vehicle with appropriate wheel chocks; making sure the vehicle's transmission is in 1st gear (manual) or " Park" (automatic).

! It is very important that the vehicle is properly supported during this installation to prevent personal injury and chassis damage. Make sure that the support stands are properly placed prior to performing the following procedures. We **DO NOT RECOMMEND** using wheel ramps while performing this installation. !

2) FRONT REMOVAL INSTRUCTIONS

- a) Jack up the front of the vehicle. Place jack stands under the frame rails and lower onto jack stands letting the front suspension hang.
- b) Remove the factory splash guards under the engine and transmission. **(PHOTO 1)**
- c) Undo the lug nuts (21mm if OEM) and remove the wheels.
- d) Remove the sway bar with end links from the vehicle. **(PHOTO 2)**
- e) Remove the tie-rod nut. Strike the side of the mount with a dead blow hammer or use a puller tool to dislodge the tie rod end. **(PHOTO 3)**
- f) Remove all mounting points for the brake line and abs sensor wire from the control arm and spindle. **(PHOTO 4)**

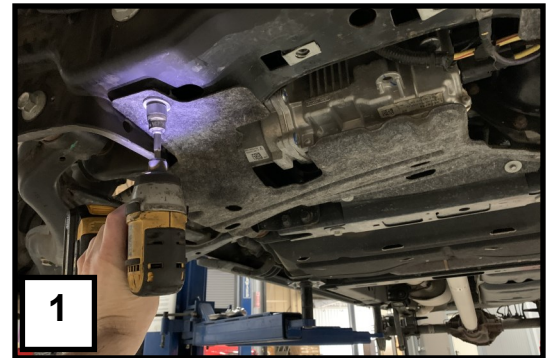
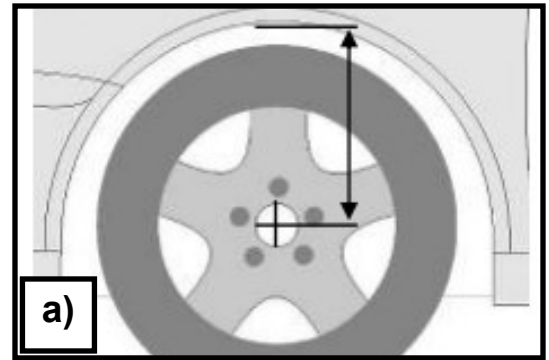

- a) Undo the Brake Caliper mounting bolts. Hang the calipers to prevent stretching of the lines using large zip ties or hangers. Remove the rotors. **(PHOTO 5)**
- b) Remove the brake backing plate and the ABS sensor from the Spindle. **(PHOTO 6)**
- h) Remove the cap in the center of the hub assembly with a pair of wide jaw pliers to expose the axle nut. Remove the nut using a 13mm socket. **(PHOTO 7)**
- i) Remove the Vacuum actuator line from the behind the Spindle/hub assembly by carefully pulling it. **(PHOTO 8)**
- j) Loosen but do not remove the nuts from the upper and lower ball joints. Use a hammer or puller tool to dislodge the spindle from the ball joints.
- k) Remove the spindle from the vehicle.

! Always be careful not to damage the vacuum actuator or grease seals with the axle shaft while removing or installing spindles.! (PHOTO 9)



- h) Using a 18mm socket, remove the lower strut mounts from the control arms (**PHOTO 10**)
- i) Using a 21mm and 27mm wrench, remove both lower control arms. (**PHOTO 11**)
- j) Remove top mount nuts and remove both front struts from the vehicle. Set aside (**PHOTO 12**)
- k) Unplug the electrical wires for the power steering rack. Pull back red lock tabs, and squeeze release buttons to remove connectors (**PHOTO 13**)
- l) Use the drivers seatbelt, or a steering wheel holder tool to hold the steering wheel from rotating. Remove the pinch bolt from the steering input shaft and separate shaft from steering rack. (**PHOTO 14**)

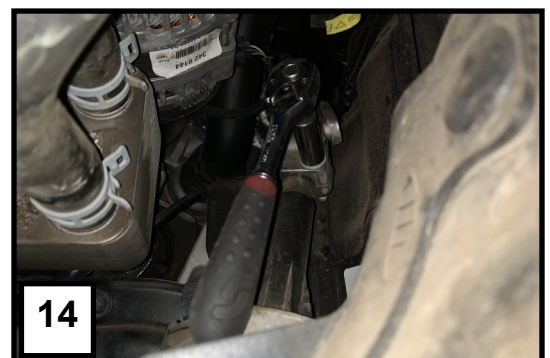
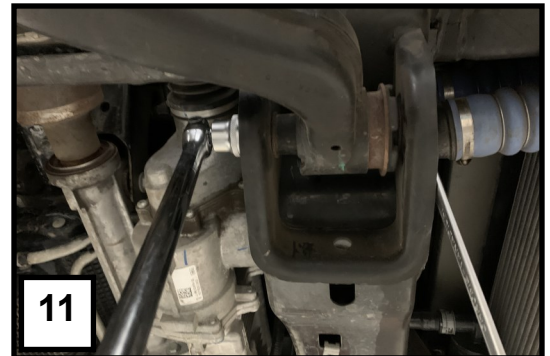

- m) Remove the 2 bolts holding the steering rack to the frame and carefully remove the power steering rack. Do not turn the input shaft, so it can be reinstalled in the same orientation. **(PHOTO 15)**
- n) Disconnect driveline and rubber vent hose from the front differential. Support the front driveline by hanging it to prevent damage. **(PHOTO 16, 17)**
- o) Remove center section of rear crossmember (near the rear of the front differential)
- p) Remove front differential from vehicle.
- q) Once the differential is out, reinstall the power steering rack in reverse order of removal. Once installed, you may remove the steering wheel holder.
- r) Using the template in the back of these instructions, mark a guide line on the DRIVERS SIDE of the rear crossmember mount. Cut on the marked line to create room for the re-located differential. Grind any rough edges and apply paint to prevent rust. **(PHOTO 18, 19, 20)**
- s) Remove factory hubs and vacuum actuators from front spindles. Take note of the orientation of the ABS port and vacuum nipples **(PHOTO 21)**

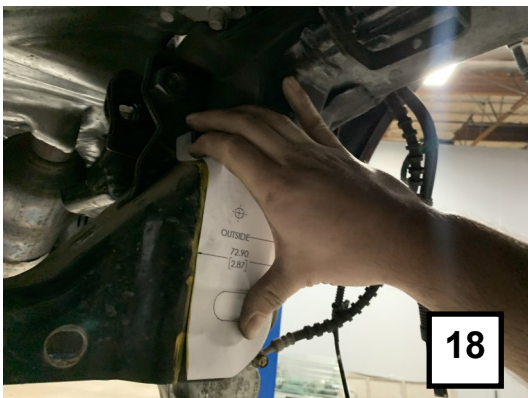
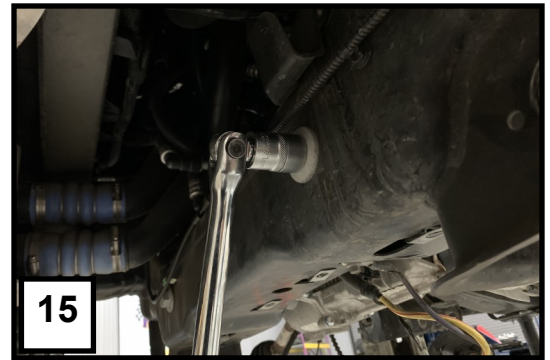

2) FRONT INSTALL INSTRUCTIONS

- a) Install front differential drop bracket to differential using supplied hardware. Do not fully tighten the bolts yet. Attach the new extended differential vent hose as shown. **(PHOTO 22)**
- b) Supporting the front differential with a floor jack, install it into the frame using OE hardware.
- c) Install the rear crossmember into the frame using supplied M18 hardware. Insert bolts from the rear, but do not install nuts yet. Align the rear differential mounting bushing into the crossmember and install with supplied hardware. **(PHOTO 23)**
- d) Support rear crossmember with a floor jack. One side at a time, remove crossmember mounting bolt, and reinstall with the sway bar drop bracket attached. **(PHOTO 24)**
- e) Attach top of sway bar drop bracket to the frame with OE hardware. Snug nuts up, but do not tighten fully.
- f) Torque all rear crossmember bolts to 180 ft lbs. Torque front differential/bracket bolts and sway bar drop bracket bolts to OE spec.
- g) Using the supplied front driveline spacer and extended hardware, reattach the front driveline to the differential. Torque to OE spec. **(PHOTO 25)**
- h) Attach the new extended differential vent hose extension to the factory plastic hose.
- i) Install front crossmember with supplied hardware. Torque bolts to 180 ft lbs **(PHOTO 26)**

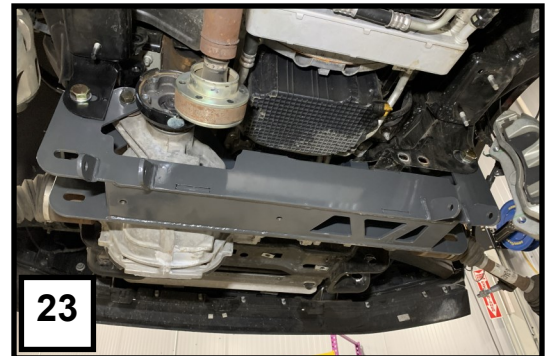

- j) Loosely install lower control arms into the new cross-members with OE hardware. **(PHOTO 27)**

For Strut Spacer Installation:

Please refer to the included instructions for strut spacer 152501-120. All required hardware is provided.

For Trail Performance Strut Installation:

Please refer to the instructions for setting ride height included within the strut 28007.

- k) Reinstall factory hubs and vacuum actuators into the new lift spindles. Make sure to keep proper alignment of the ABS sensor port and vacuum hose fittings. Tighten hardware to OE specs. **(PHOTO 28)**
- l) Install new lift spindles onto vehicle. Make sure the front axle is fully seated into the hub. Tighten upper and lower ball joints, as well as the axle nuts. Torque all to OE spec and reinstall dust caps over spindle nuts. **(PHOTO 29)**
- m) Unbolt front brake line brackets from frame. Unclip the lines from any attachments to the frame near the control arm mount to allow everything to be moved downward. **(PHOTO 30 & 31)**

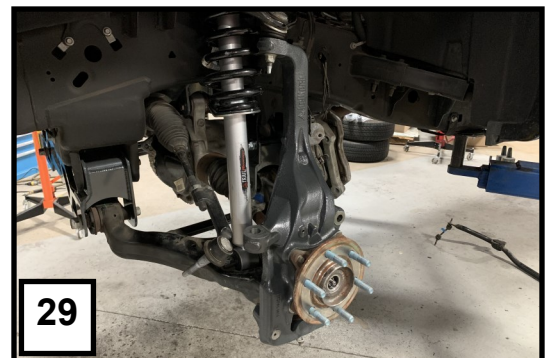
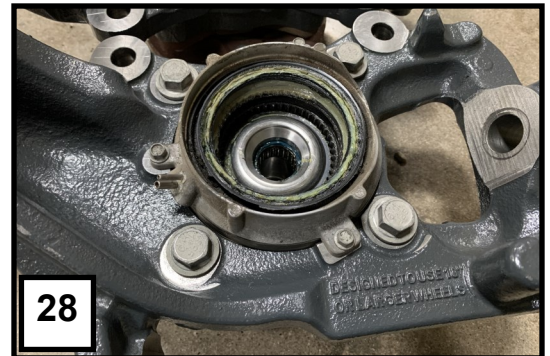

- n) Install new brake line drop brackets to the frame with OE hardware. **(photo 32)**
- o) Install OE brake line to new bracket with supplied hardware. Remove any retaining clips necessary to allow hard lines to flex downward toward the new bracket.
- p) Attach vacuum actuator hoses and ABS sensor to spindle.
- q) Install brake rotor and caliper onto spindle. **(PHOTO 33 &34)**
- r) Attach outer tie rod to spindle. Torque to OE spec. **(PHOTO 35)**
- s) Double check all ABS and brake lines to confirm they will not interfere with other moving parts or be pulled on while steering.
- t) Install sway bar onto new drop brackets using supplied hardware. Attach end links to control arms using OE nuts. **(PHOTO 36)**

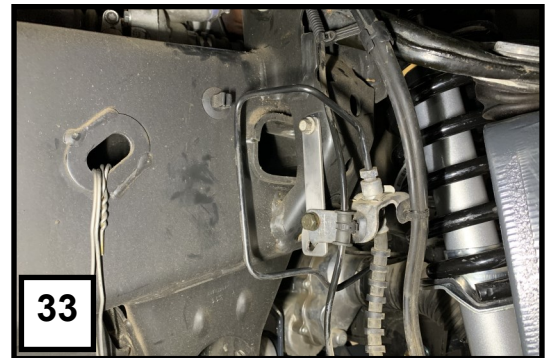

- u) Remove nuts from the center crossmember near the transmission. **DO NOT REMOVE THE BOLTS. (PHOTO 37)** **Some models may have a wire harness on the passenger side. Temporarily remove the bolts holding the harness to the crossmember to access the crossmember bolts.** **(PHOTO 38)**
- v) Install compression arm rear mounting brackets using OE nuts and bolts. Reattach wire harness if removed. **(PHOTO 39)**
- w) Press the supplied compression arm bushings and sleeves into the compression arms. Using supplied hardware, install the compression arms into the tabs on the rear crossmember, and the previously installed brackets. **(PHOTO 40)**
- x) Mount Skid plate across both crossmembers using supplied hardware. **(PHOTO 41)**
- y) Install wheels. Lower vehicle back onto the ground. Torque the wheels and lower control arm bolts.
- z) Check torque of all fasteners and check for interference of all brake lines and moving parts.

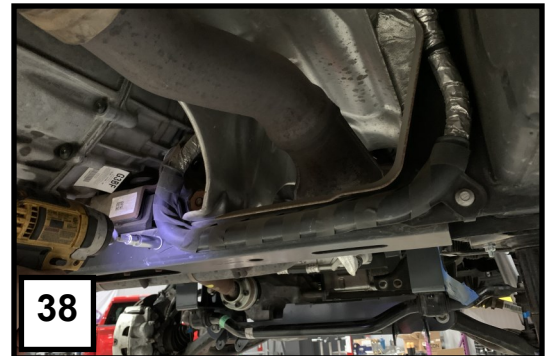

3) REAR REMOVAL INSTRUCTIONS

- a) Jack up the rear of the vehicle. Place jack stands under the frame rails and lower onto jack stands letting the rear suspension hang.
- b) Supporting the differential with a floor jack, Remove Rear shocks. Hardware will be reused. **(PHOTO 1)**
- c) Disconnect brake line bracket from the inside of the driver frame rail above the axle. **(PHOTO 2)**
- d) Using a pry tool. Release the rear 2 brake line retention clips from the frame rail. This will allow the brake line bracket to be lowered without kinking the hard lines. **(PHOTO 3)**
- e) Using a 13mm socket on an extension, remove factory bump stop cup from the frame. **(PHOTO 4)**
- f) Keeping the axle fully supported, lower it until the leaf springs are decompressed.
- g) Remove all 8 U bolt nuts and U bolts. The lower U bolt plates will be reused. **(PHOTO 5)**
- h) Lower the axle to make room to install the new lift blocks. Remove OE blocks if equipped.

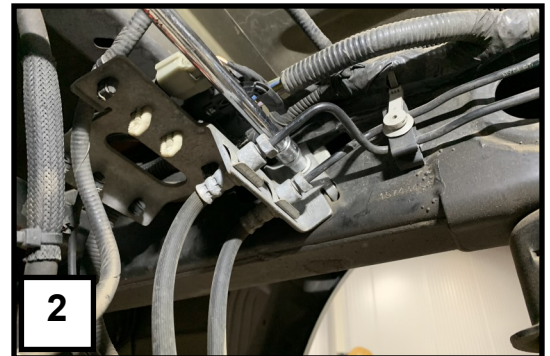

4) REAR INSTALL INSTRUCTIONS

- i) Install rear lift blocks with the taller end in the back to aim the pinion up toward the transmission. **(PHOTO 6)**
- j) Making sure all pins and holes are aligned and seated. Raise the axle against the leaf springs to close all gaps.
- k) Install the new U-bolts using the provided hardware and OE lower U bolt plates. Torque to 90 ft lbs.
- l) Install new rear BELLTECH TRAIL PERFORMANCE shocks (TP2722EE) using the OEM hardware. **(PHOTO 7)**
- m) Install Brake line drop bracket onto frame, reusing OE bolt. **(PHOTO 8)**
- n) Install brake lines to the drop bracket using the provided M8 hardware. **(PHOTO 9)**
- o) Remove the OEM bump stop cup/bump stop **(PHOTO 10)**
- p) Flatten or cut off locating tabs on bump stop cups. **(PHOTO 11)**
- q) Reinstall bump stops with provided composite spacer and extended hardware, making sure it is rotated in the correct orientation. **(PHOTO 12)**
- r) Reinstall wheels if removed, and lower truck to the ground.
- s) Double check torque of all components.



4) **Post Install**

- a) Check that all components and fasteners have been properly installed, tightened and torqued.
- b) Check brake hoses, and other components for any possible interference.
- c) Torque all lug nuts to OEM (factory) specifications.
- d) Test drive the vehicle in a remote location so that you can become accustomed to the altered driving characteristics and handling. Be aware that the vehicle will handle substantially different now that it has been modified.
- e) We recommend the vehicle be taken to a qualified wheel alignment facility to be realigned to factory specifications after completing the install.
- f) Installation is complete. Check ALL of the hardware and re-torque at intervals for the first 10, 100, 1000 miles.

COMPONENTS PARTS LIST

152501BK KIT		
P/N	ITEM DESCRIPTION	QTY
LK51000	COMPONENTS KIT	1
LK5001	COMPONENT KIT	1
LK2352	COMPONENT KIT	1
LK2003	STRUT SPACER KIT	1
LK9705R	LK SHOCK SET	1

LK51000		
P/N	ITEM DESCRIPTION	QTY
152501-101-99	FRONT CROSSMEMBER	1
152501-102-99	REAR CROSSMEMBER	1
152501-113L-99	SWAYBAR DROP DOWN BRKT DRIVER SIDE	1
152501-113R-99	SWAYBAR DROP DOWN BRKT PASSENGER SIDE	1
152501-107L-99	COMPRESSION ARM BRKT DRIVERSIDE	1
152501-107R-99	COMPRESSION ARM BRKT PASSENGER SIDE	1
152501-201-99	LIFT BLOCK	2

LK5001		
P/N	ITEM DESCRIPTION	QTY
152501-106-99	COMPRESSION ARM	2
152501-108-99	SKIT PLATE	1
152501-104-99	DIFFERENTIAL DROP DOWN BRKT	1
152501-202	U-BOLT (M14-2.0 x 12.5" x 3.75")	4
LK5001A	SUB-KIT -A	1

LK2352		
P/N	ITEM DESCRIPTION	QTY
152501-103L	SPINDLE DRIVER SIDE	1
152501-103R	SPINDLE PASSENGER SIDE	1

152501TP KIT		
P/N	ITEM DESCRIPTION	QTY
LK51000	COMPONENTS KIT	1
LK5001	COMPONENT KIT	1
LK2352	COMPONENT KIT	1
LK9705F	LK SHOCK SET	1
LK9705R	LK SHOCK SET	1

LK2003		
P/N	ITEM DESCRIPTION	QTY
152501-120	STRUT SPCER	2

LK9705F		
P/N	ITEM DESCRIPTION	QTY
28007	TRAIL PERFORMANCE STRUT	2

LK9705R		
P/N	ITEM DESCRIPTION	QTY
TP2722EE	TRAIL PERFORMANCE SHOCK	2

LK5001A		
P/N	ITEM DESCRIPTION	QTY
152501-141	VENT TUBE EXTENSION	1
152501-111-95	FRONT BRAKE LINE BRKT	2
152501-140-95	DRIVE-LINE SPACER	1
150210-203	REAR BUMP STOP EXTENSION	2
152501A-777	HARDWARE KIT CROSSMEMBERS	1
152501B-777	HARDWARE KIT DIFFERENTIAL DROP BRKT	1
152501C-777	HARDWARE KIT COMPRESSION ARMS	1
152501D-777	HARDWARE KIT U-BOLT/BUMP STOPS	1
152501F-777	HARDWARE KIT SKID PLATE	1
152501G-777	HARDWARE KIT BRAKE LINE BRKTS	1
152501J-777	HARDWARE KIT FRONT SWAYBAR	1

HARDWARE PARTS LIST

152501A-777		
P/N	ITEM DESCRIPTION	QTY
112131	M18-2.5 x 140 BOLT	4
112132	M18-2.5 NUT	4
112133	M18 WASHER	8

152501B-777		
P/N	ITEM DESCRIPTION	QTY
110220	M14-2.0 x 100 BOLT	3
110222	M14-2.0 NUT	3
110223	M14 WASHER	6

152501C-777		
P/N	ITEM DESCRIPTION	QTY
150201-100-HW	COMPRESSION ARM BUSHINGS	1
110227	M12-1.75 x 110MM BOLT	4
110243	M12-1.75 NUT	4

152501F-777		
P/N	ITEM DESCRIPTION	QTY
112142	M10-1.5 X 25MM BOLT	4

152501G-777		
P/N	ITEM DESCRIPTION	QTY
110232	M8-1.0 X 16MM BOLT	4
110233	M8-1.0 NUT	4
110245	M8 WASHER	8

152501D-777		
P/N	ITEM DESCRIPTION	QTY
110287	M10-1.5 x 130MM BOLT	2
110223	M14 WASHER	8
110222	M14-2.0 NUT	8

152501J-777		
P/N	ITEM DESCRIPTION	QTY
110230	M10-1.25 X 25MM	4
110244	M10-1.25 NUT	4
110239	M10 WASHER	8

Crossmember Cut Template

Scale to print vertical height of 209mmm

