



INSTALLATION GUIDE

PART NUMBER: 2352
LOWERING SPINDLE
FORD F150 2WD | 2015-2020

-2" FRONT LOWERED RIDE HEIGHT

****MUST USE 20" WHEELS OR LARGER, FITS MOST 20" WHEELS. MUST CHECK FOR INTERFERENCE****

300 W. PONTIAC WAY. CLOVIS, CA 93612
PHONE: 800-445-3767 | EMAIL: INFO@BELLTECH.COM

THANK YOU

Thank you for choosing our high quality Belltech product. We have spent a great deal of time developing our line of products so that you will receive maximum performance with minimal difficulty during installation. Soon your vehicle will be on the road looking and feeling much improved.

Please take a moment to read all instructions and warnings prior to installation of your new Belltech product and before operating your vehicle. If you have any questions or concerns regarding any step in the installation process, please do not hesitate to call or email our customer support specialists who are trained to help you through any portion of this process.

Before You Begin:

It is of the utmost importance that you confirm all of the components listed on the parts list is in the kit. You can find this list located on the last page(s) of your instructions. Do not begin installation if any part is missing. Instead, please call our Belltech customer service specialists.

Belltech Customer Support:

Phone: 1-800-445-3767

Email: info@belltech.com

Safety Information:

Warning: Do not work under a vehicle supported only by a jack. Place support stands securely under the vehicle in the manufacturer's specified locations unless otherwise instructed.

Proper use of safety equipment and eye/face/hand protection is absolutely necessary when performing any of the following instructions.

We strive for an exceptional experience for all our valued customers. If for any reason you need assistance with your Belltech products, please do not return the product to the store you purchased from, but rather call our dedicated customer service experts, from 7am to 5pm PST.

We recommend that a qualified mechanic, at a properly equipped facility, perform this installation.

It is very helpful to have an assistant available during installation.

Before Driving Your Vehicle:

It is important to double check all brake hoses, cables, and other components to be sure there is no interference. You must also check for wheel/tire to chassis/body interference. If any issues are found, review your installation instructions to be sure no steps were missed and any problems are corrected.

Make sure your vehicle is aligned immediately following installation.

Check all hardware and torque at intervals for the first 10, 100, and 1000 miles.

Some of Belltech's products are designed to improve your vehicle's off-road performance. Leveling/lifting your vehicle may result in an altered center of gravity. It is crucial to use extreme care when operating your vehicle to prevent rollover and/or loss of control.

Any changes in your vehicle's suspension may result in transformed handleability. Please test-drive your vehicle in a remote location so you can become accustomed to the revised driving characteristics.

Perform headlight check and adjustment.

Failure to drive any modified vehicle in a safe manner may result in harm or death.

Never operate your modified vehicle under the influence of drugs, alcohol, or lack of adequate sleep.

Always wear your seatbelt.



DIFFICULTY:

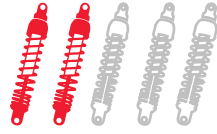

INSTALLATION TIME:

1-2 Hours + Alignment

RECOMMENDED TOOLS:

- Properly rated floor jack
- Support stands
- Wheel chocks
- Metric socket wrench set
- Metric wrench set
- Tape measure
- Hammer and rubber mallet
- Torque wrench rated up to 150 ft lbs.

SPECIALTY TOOLS:

- Trim removal tool
- Tie rod end removal tool
- Ball joint separator tool
- Transmission jack
- Abrasive cutter or grinder



FITMENT GUIDE

Must use 20" wheels or larger. It is important to note this kit fits **most** 20" wheels. Please be sure to check for interference.

Not all possible wheel sizes and backspacing can be tested. Cautiously check wheel assembly to spindle, suspension component, and fender/body clearance before tightening lug nuts and rotating the wheel assembly. Belltech is not responsible for any wheel, tire, suspension component, and/or body damage caused by failure to check for interference.

INSTALLATION PREPARATION:

Before beginning the installation process, measure the hub to fender heights for your vehicle and record them in the "Before" section. After your vehicle has been modified, record the new measurements in the, "After" section. This way, you can compare the resulting height to the original. When taking the measurements, measure vertically from the center of the wheel to the inner edge of the fender.

Before:

LF: _____

RF: _____

LR: _____

RR: _____

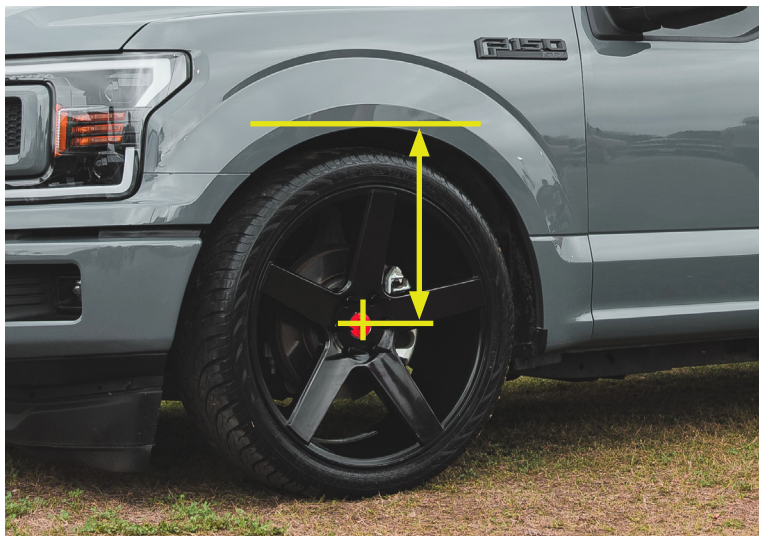

After:

LF: _____

RF: _____

LR: _____

RR: _____

JACKING, SUPPORTING, AND PREPARING THE VEHICLE

1. Park your vehicle on a smooth, level, concrete or seasoned asphalt surface.
2. Block the rear wheels of the vehicle using wheel chocks. Make sure the vehicle's transmission is in "PARK" (automatic) or 1st gear (manual).
3. Activate the parking brake.
4. Loosen, but do not remove, the front wheel lug nuts.
5. Lift the front of the vehicle off the ground using a properly rated floor jack. Lift the vehicle so the front tires are approximately 6-8 inches off the ground.
6. Place support stands rated for the vehicles weight. The stands should be positioned in the factory specified locations. (Refer to the owners manual). Prior to lowering the vehicle onto stands, make sure the support stands will contact the chassis. It is very important that the vehicle is properly supported to prevent any harm to ones self or to the vehicle.
7. Lower the vehicle slowly onto the stands.
8. Remove the front wheels.



Technician reminder:

Never work under a vehicle supported only by a jack. It is necessary to place support stands securely under the vehicle in the manufacturer's specified locations unless otherwise instructed.

OEM SPINDLE REMOVAL

9. Remove the 21mm nut on the steering arm tie rod end. To detach the ball joint from the spindle, carefully strike the boss with a hammer or rubber mallet.



10. Remove the 10mm nut holding the brake line bracket to the spindle. Also remove the clips holding the lines to the chassis with a trim removal tool.

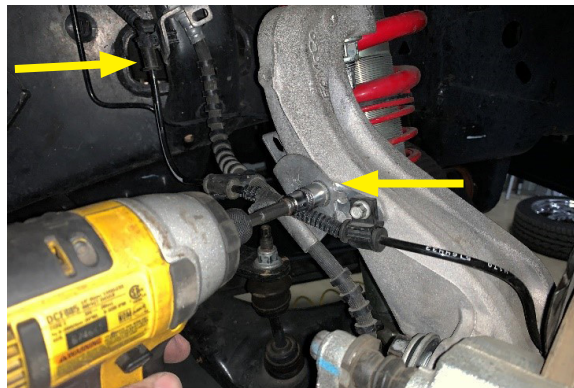

11. Remove the 21mm bolts from brake caliper assembly and detach from the spindle. With a metal hook, wire, or zip tie attach the caliper to the chassis to prevent damage to the brake line and clear the work space.



OEM SPINDLE REMOVAL CONTINUED

12. Remove the brake rotor and dust shield.



13. Detach the ABS sensor from the hub with a 5mm hex key.

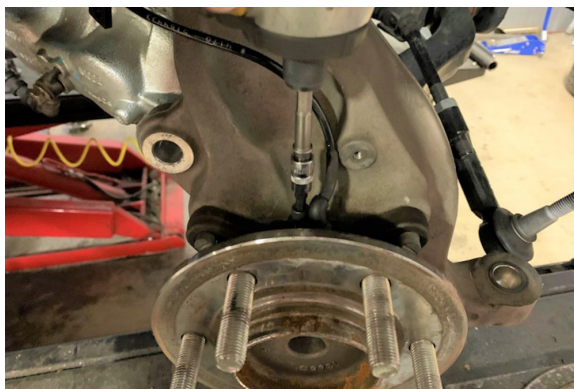

14. Break loose but do not remove the 18mm upper ball joint nut.

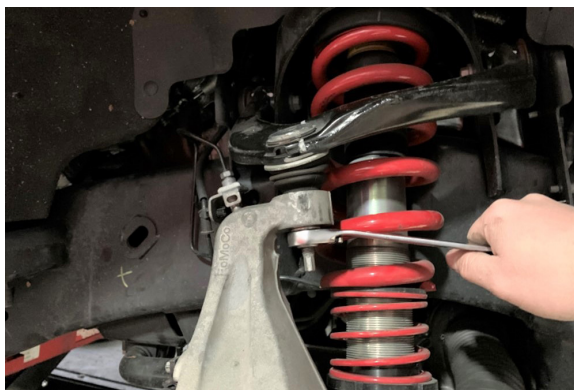

OEM SPINDLE REMOVAL CONTINUED

15. Use a hammer or rubber mallet to strike the side of the ball joint boss to detach the ball joint from the spindle.



16. Remove the upper ball joint nut and detach the upper ball joint from the spindle.
17. Remove the 21mm lower ball joint nut and detach the lower ball joint from the spindle.

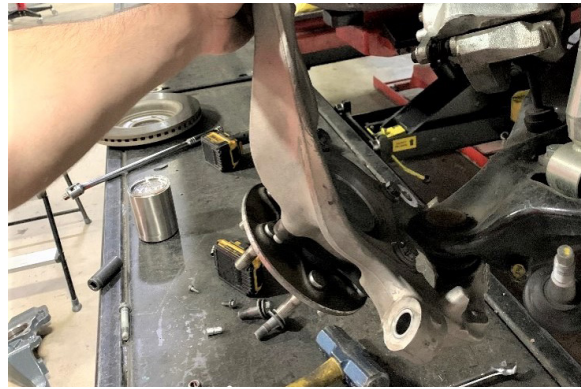
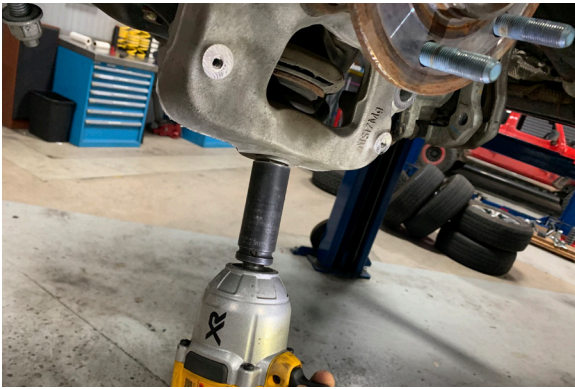

18. Remove the four 18mm hub bolts to detach the hub from the spindle. Note the orientation of the hub as the ABS sensor will need to be connected in the same position.



BELLTECH SPINDLE FITMENT GUIDE



Technician warning:

For 20" wheels you MUST confirm adequate clearance between the wheel and lower ball joint. Only if needed, the ball joint stud must be trimmed. Ensure you leave between 1/16" to 1/8" of the stud extended out from the nut. Depending on your wheel clearance, this may be adjusted. Once the proper length is trimmed off, use a chisel or punch to score the edge of the threads to prevent the possibility of the nut becoming loose.

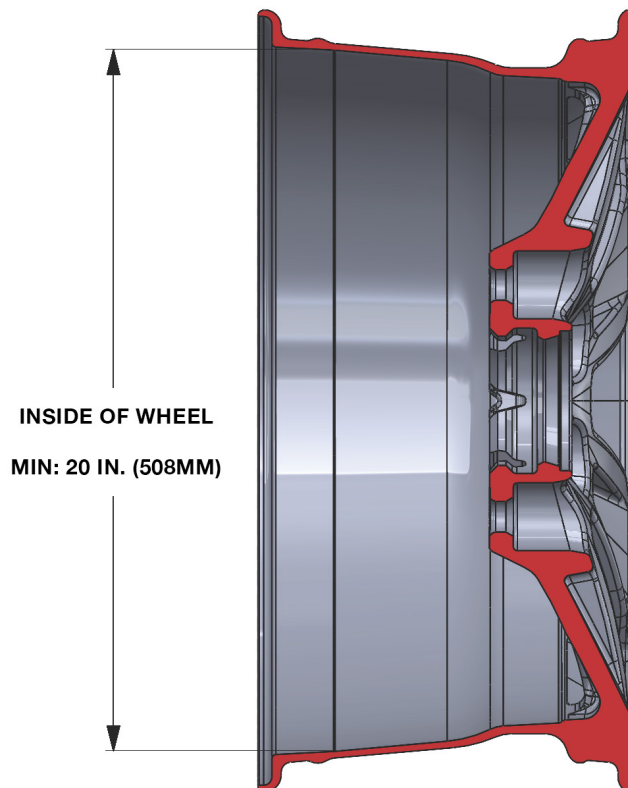
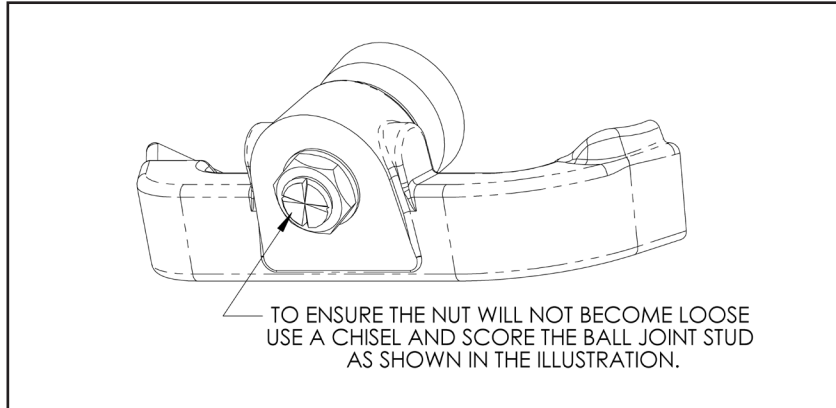

BELLTECH SPINDLE INSTALLATION

20. Attach the OEM hub onto the new Belltech spindle. Ensure the ABS sensor mount is facing upward. Torque the bolts to 129 ft lbs.

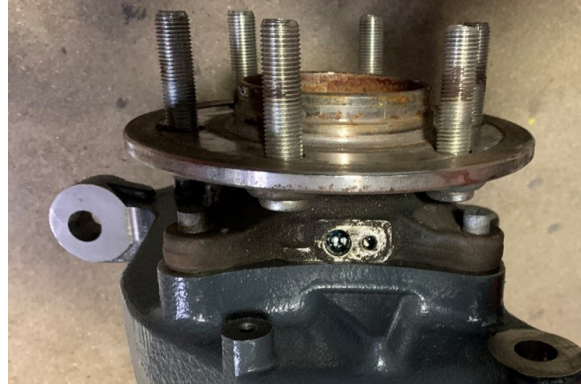

22. Mount the Belltech spindle onto the bottom ball joint and secure the bottom nut so it is hand tight, do not torque yet.

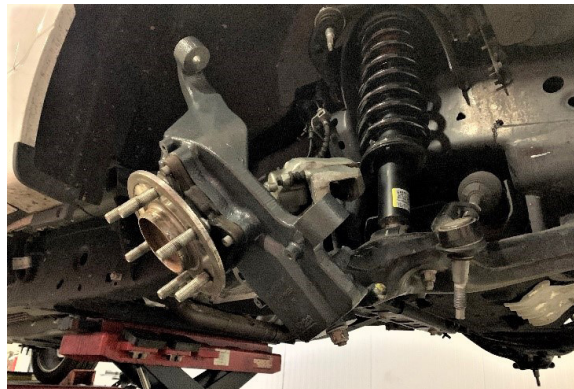

23. Mount the upper ball joint onto the Belltech spindle and secure the upper ball joint nut so it is hand tight, do not torque yet.

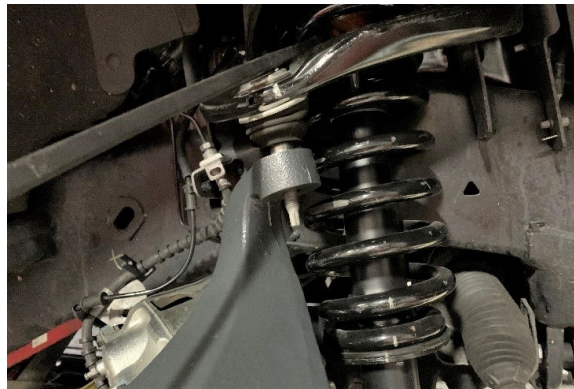

24. Raise the lower control arm with a transmission or floor jack to simulate a load on the suspension. Torque the lower ball joint nut to 98 ft lbs. and the upper ball joint nut to 46 ft lbs.



BELLTECH SPINDLE INSTALLATION CONTINUED

25. Reconnect the ABS sensor onto the wheel hub.



Technician reminder:

Ensure the area around the ABS mount is free of dirt and debris to prevent system failure.

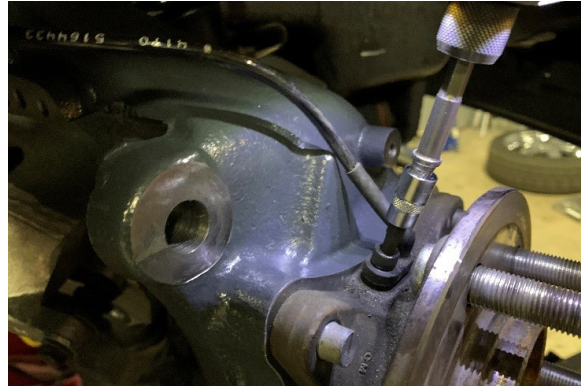

26. Attach the OEM dust shield using the original bolts; torque to 133 in lbs. Place the brake rotor onto the wheel hub.



27. Place the caliper over the rotor and fasten it onto the Belltech spindle using OEM bolts. Torque the caliper anchor plate bolts to 184 ft lbs.

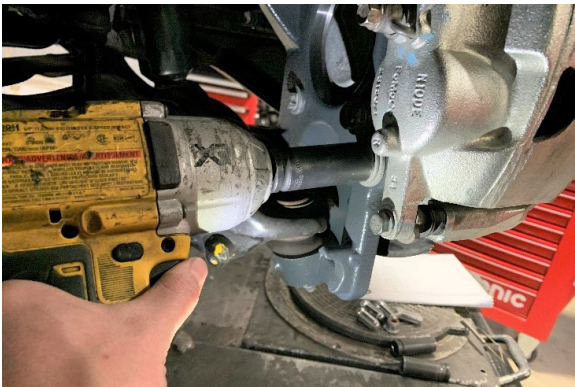

BELLTECH SPINDLE INSTALLATION CONTINUED

28. Attach the brake line clips to the chassis. Mount the brake line bracket onto the Belltech spindle with the original hardware. Torque to 22 ft lbs.

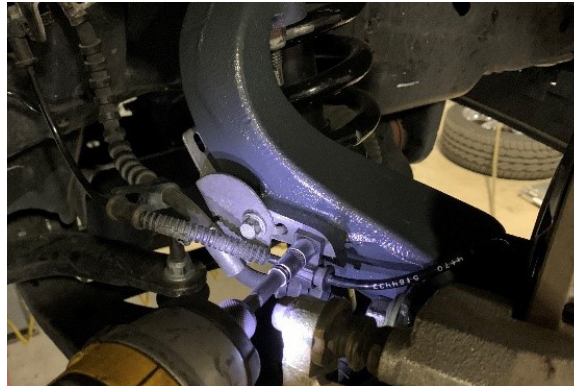

29. Mount the steering tie rod end onto the Belltech spindle and torque to 66 ft lbs.



Technician reminder:

If the tie rod end stud spins, use the a 10mm socket/wrench to hold it while you torque.

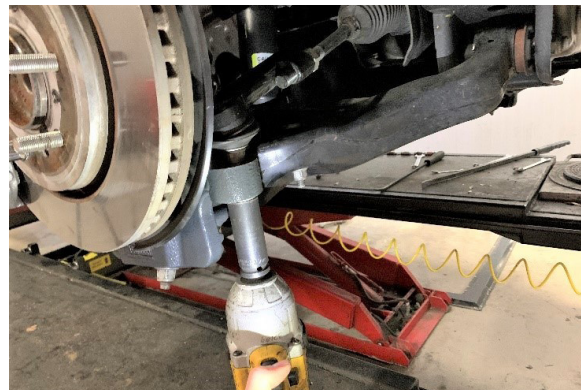

FINALIZING THE INSTALLATION

31. Mount the wheels and tighten the lug nuts.
32. Lift the vehicle and remove the support stands.
33. Carefully lower the vehicle onto the flat ground.
34. Torque the lug nuts to 150 ft lbs.
35. Check that all components and fasteners have been properly installed and torqued.
36. Read and perform all tasks in the “Before Driving Your Vehicle” section of page 1 of your instructions.

THANK YOU FOR CHOOSING BELLTECH.

You are now a part of the Belltech family and we are eager to catch a glimpse of your newly modified vehicle. Give us a shout out and let us know how much you love our product. Don't forget, we offer other Belltech related merchandise for you and your vehicle on our website www.belltech.com

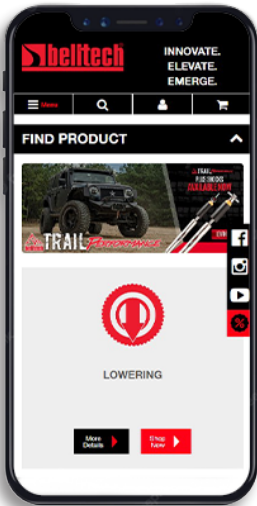

[belltechsuspension](https://www.facebook.com/belltechsuspension)



[Belltech Suspension](https://www.youtube.com/BelltechSuspension)



[@belltechsuspension](https://www.instagram.com/belltechsuspension)

If you have any questions, concerns, or warranty related issues regarding your Belltech product, please call or email our experienced customer service specialists.

Belltech Customer Support:

Phone: 1-800-445-3767

Email: info@belltech.com

KIT CONTENTS



Drop Spindle Set		
Part number	Description	Qty
2352-325	LH MACHINED SPINDLE	1
2352-425	RH MACHINED SPINDLE	1